

HP 3100 Fax series User Guide

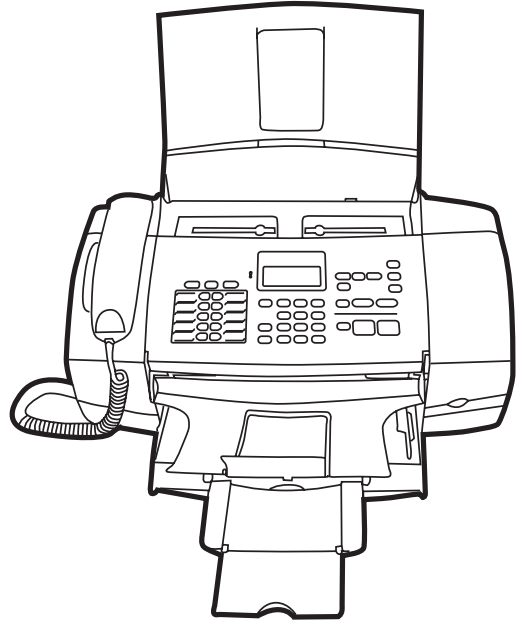

HP 3100 Fax series

User Guide



Copyright information

© 2008 Copyright Hewlett-Packard
Development Company, L.P.

Hewlett-Packard Company notices

The information contained in this document is subject to change without notice.

All rights reserved. Reproduction, adaptation, or translation of this material is prohibited without prior written permission of Hewlett-Packard, except as allowed under copyright laws.

The only warranties for HP products and services are set forth in the express warranty statements accompanying such products and services. Nothing herein should be construed as constituting an additional warranty. HP shall not be liable for technical or editorial errors or omissions contained herein.

Safety information



Always follow basic safety precautions when using this product to reduce risk of injury from fire or electric shock.

1. Read and understand all instructions in the documentation that comes with the HP Fax.
2. Use only a grounded electrical outlet when connecting this product to a power source. If you do not know whether the outlet is grounded, check with a qualified electrician.
3. Observe all warnings and instructions marked on the product.
4. Unplug this product from wall outlets before cleaning.
5. Do not install or use this product near water, or when you are wet.
6. Install the product securely on a stable surface.
7. Install the product in a protected location where no one can step on or trip over the line cord, and the line cord cannot be damaged.
8. If the product does not operate normally, see [Maintain and troubleshoot](#).
9. There are no user-serviceable parts inside. Refer servicing to qualified service personnel.

Contents

1 Get started

| | |
|---|----|
| Find other resources for the product | 5 |
| Understand the HP Fax parts..... | 5 |
| Front view..... | 6 |
| Back view..... | 6 |
| Control panel buttons and lights..... | 7 |
| Load full-size paper..... | 8 |
| Load originals..... | 10 |
| Change HP Fax settings..... | 11 |
| Send a basic fax..... | 11 |
| Set the answer mode..... | 12 |
| Set up faxing for the HP Fax | 12 |
| Set up faxing (parallel phone systems)..... | 13 |
| Serial-type fax setup..... | 14 |

2 Use the HP Fax

| | |
|---|----|
| Control panel menus..... | 15 |
| Use control panel menus..... | 16 |
| Control-panel message types..... | 16 |
| Text and symbols..... | 17 |
| Type numbers and text on the control-panel keypad..... | 17 |
| To enter text..... | 17 |
| To enter a space, pause, or symbol..... | 18 |
| To erase a letter, number, or symbol..... | 18 |
| Available symbols for dialing fax numbers..... | 18 |
| Set up speed-dial entries..... | 18 |
| Set up fax numbers as speed-dial entries or groups..... | 19 |
| Set up speed-dial entries..... | 19 |
| Set up a speed-dial group..... | 19 |
| Print and view a list of speed-dial entries..... | 20 |
| Select print media..... | 20 |
| Tips for selecting and using print media..... | 20 |
| Understand specifications for supported media..... | 21 |
| Understand supported sizes..... | 21 |
| Understand supported media types and weights..... | 21 |
| Set minimum margins..... | 21 |

3 Fax

| | |
|--|----|
| Send a fax..... | 22 |
| Send a fax manually from a phone..... | 22 |
| Send a fax using monitor dialing..... | 24 |
| Send a fax from memory..... | 24 |
| Schedule a fax to send later..... | 25 |
| Send a fax to multiple recipients..... | 25 |
| Send a color original or image/embedded picture fax..... | 26 |
| Change the fax resolution and Lighter/Darker settings..... | 27 |
| Change the fax resolution..... | 27 |
| Change the Lighter / Darker setting..... | 28 |
| Set new default settings..... | 28 |
| Send a fax in Error Correction Mode..... | 29 |
| Receive a fax..... | 29 |
| Receive a fax manually..... | 29 |
| Set up backup fax reception..... | 30 |
| Reprint received faxes from memory..... | 31 |
| Poll to receive a fax..... | 31 |
| Forward faxes to another number..... | 32 |
| Set the paper size for received faxes..... | 32 |
| Set automatic reduction for incoming faxes..... | 33 |
| Block junk fax numbers..... | 33 |
| Set the junk fax mode..... | 33 |
| Add numbers to the junk fax list..... | 34 |
| Remove numbers from the junk fax list..... | 34 |
| Change fax settings..... | 35 |
| Configure the fax header..... | 35 |
| Set the number of rings before answering..... | 35 |
| Change the answer ring pattern for distinctive ring..... | 36 |
| Set the fax error correction mode..... | 36 |
| Set the dial type..... | 36 |
| Set the redial options..... | 37 |
| Set the fax speed..... | 37 |
| Fax over the Internet..... | 38 |
| Cancel a fax..... | 38 |

4 Copy

| | |
|--|----|
| Make copies from the control panel..... | 39 |
| Change the copy settings..... | 39 |
| Set the number of copies..... | 40 |
| Set the copy paper size..... | 40 |
| Set the copy paper type..... | 40 |
| Change copy speed or quality..... | 41 |
| Resize an original to fit onto letter or A4 paper..... | 41 |
| Copy a legal-size document onto letter paper..... | 42 |
| Adjust the lightness and darkness of your copy..... | 42 |
| Enhance blurred areas of your copy..... | 42 |
| Enhance light areas of your copy..... | 43 |
| Cancel a copy job..... | 43 |

5 Configure and manage

Manage the HP Fax.....44
Use reports.....44
 Print fax confirmation reports.....44
 Print fax error reports.....45
 Print and view the fax log.....45
Test fax setup.....46
The fax test failed.....46

6 Maintain and troubleshoot

Work with print cartridges.....51
 Print cartridges.....51
 Handle the print cartridges.....52
 Replace the print cartridges.....52
 Align the print cartridges.....55
 Clean the print cartridges.....55
 Clean the print cartridge contacts.....56
 Clean the area around the ink nozzles.....57
 Store print cartridges.....58
Clean the HP Fax.....59
 Clean the glass strip.....59
 Clean the white strip.....60
 Clean the exterior.....61
Troubleshooting tips and resources.....61
Solve printing problems.....61
Poor print quality and unexpected printouts.....62
Solve paper-feed problems.....63
Solve copy problems.....63
Solve fax problems.....65
Troubleshoot setup issues.....70
Clear paper jams.....71
Avoid paper jams.....72

A HP supplies and fax specifications

Order printing supplies online.....73
Supplies.....73
 HP media.....73
 Print cartridges.....73
Physical specifications.....74
Product features and capacities.....74
Memory specifications.....74
Print specifications.....74
Copy specifications.....74
Fax specifications.....75
Environmental specifications.....75
Electrical specifications.....75
Acoustic emission specifications (noise levels per ISO 7779).....75

B Support and warranty

Obtain electronic support.....77

| | |
|---|-----------|
| Obtain HP telephone support..... | 77 |
| Before you call..... | 77 |
| Support process..... | 78 |
| HP support by phone..... | 78 |
| Phone support period..... | 78 |
| Placing a call..... | 78 |
| After the phone support period..... | 78 |
| Additional warranty options..... | 78 |
| Prepare the HP Fax for shipment..... | 78 |
| Pack the HP Fax..... | 79 |
| Warranty..... | 80 |
| C Regulatory information | |
| FCC statement..... | 81 |
| Noise emission statement for Germany..... | 82 |
| Notice to users of the U.S. telephone network: FCC requirements..... | 82 |
| Notice to users of the Canadian telephone network..... | 83 |
| Notice to users in the European Economic Area..... | 83 |
| Regulatory model number..... | 84 |
| Environmental product stewardship program..... | 84 |
| Paper use..... | 84 |
| Plastics..... | 84 |
| Material safety data sheets..... | 84 |
| Energy consumption..... | 84 |
| Recycling program..... | 84 |
| HP inkjet supplies recycling program..... | 84 |
| Disposal of waste equipment by users in private households in the European Union..... | 86 |
| Declaration of conformity..... | 87 |
| Index..... | 88 |

1 Get started

This guide provides details about how to use the HP Fax and to resolve problems.

- [Find other resources for the product](#)
- [Understand the HP Fax parts](#)
- [Load full-size paper](#)
- [Load originals](#)
- [Change HP Fax settings](#)
- [Send a basic fax](#)
- [Set the answer mode](#)
- [Set up faxing for the HP Fax](#)

Find other resources for the product

You can obtain product information and further troubleshooting resources that are not included in this guide from the following resources:

| Resource | Description | Location |
|----------------------|---|--|
| Setup poster | Provides illustrated setup information. | A printed version of the document is provided with the HP Fax. |
| Control panel | Provides status, error, and warning information about operations. | For more information, see Control panel buttons and lights . |
| Logs and reports | Provides information about events that have occurred. | For more information, see Configure and manage . |
| HP Web sites | If you have Internet access, you can get help and support from the HP Web sites. These Web sites offer technical support, supplies, and ordering information. | www.hp.com/support www.hp.com |
| HP telephone support | Lists information to contact HP. During the warranty period, this support is often free of charge. | For more information, see Obtain HP telephone support . |

Understand the HP Fax parts

- [Front view](#)
- [Back view](#)
- [Control panel buttons and lights](#)

Front view

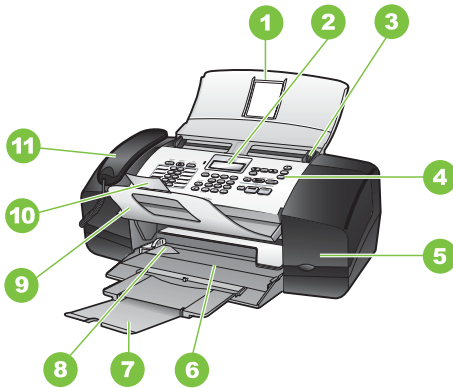

| | |
|----|---------------------------|
| 1 | Document feeder tray |
| 2 | Control panel display |
| 3 | Paper guides |
| 4 | Control panel |
| 5 | Print cartridge door |
| 6 | Input tray |
| 7 | Tray extender |
| 8 | Paper-width guide |
| 9 | Document catcher |
| 10 | Document catcher extender |
| 11 | Handset |

Back view

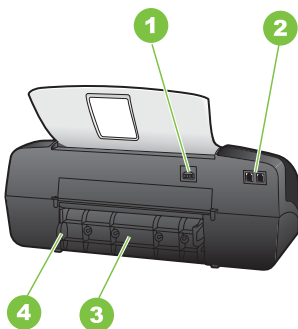







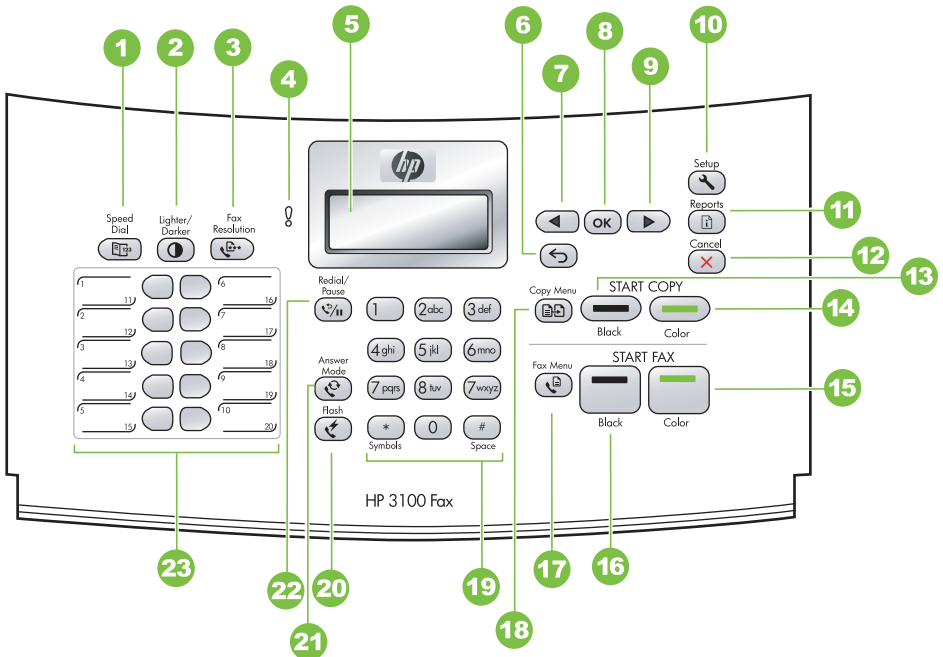



| | |
|---|------------------------------|
| 1 | Power connection |
| 2 | Fax ports (1-LINE and 2-EXT) |
| 3 | Rear door |
| 4 | Rear door access tab |

Control panel buttons and lights

The following diagram and related table provide a quick reference to the control panel features.





| Label | Icon | Name and Description |
|-------|------|--|
| 1 | | Speed Dial: Selects a speed dial number |
| 2 | | Lighter / Darker: Lightens or darkens black-and-white faxes being sent |
| 3 | | Fax Resolution: Adjusts the resolution for black-and-white faxes being sent |
| 4 | | Attention light: When blinking, the attention light indicates an error has occurred that requires your attention |
| 5 | | Display: View menus and messages |
| 6 | | Back: Moves you one level up in the menu |

| Label | Icon | Name and Description |
|-------|--|--|
| 7 |  | Left arrow: Decrease values on the display |
| 8 |  | OK: Selects a menu or a setting on the display |
| 9 |  | Right arrow: Increases values on the display |
| 10 |  | Setup: Presents the Setup Menu for generating reports and changing fax and other maintenance settings |
| 11 |  | Reports: Opens the menu of reports you can print |
| 12 |  | Cancel: Stops a job, exits a menu, or exits settings |
| 13 | | START COPY Black: Starts a black-and-white copy |
| 14 | | START COPY Color: Starts a color copy |
| 15 | | START FAX Color: Starts a color fax |
| 16 | | START FAX Black: Starts a black-and-white fax |
| 17 |  | Fax Menu: Places the HP Fax in fax mode and presents the Fax Menu . Press Fax Menu repeatedly to scroll through the options in the Fax Menu . |
| 18 |  | Copy Menu: Places the HP Fax in copy mode and presents the Copy Menu . Press Copy Menu repeatedly to scroll through the options in the Copy Menu . |
| 19 | | Keypad: Enter fax numbers, values, or text |
| 20 |  | Flash: Cancels a fax and brings up a dial tone. Also used to answer a call waiting |
| 21 |  | Answer Mode: Switches among the Answer Mode settings. Depending on the setting, the HP Fax automatically answers incoming phone calls, requires you to receive the fax manually, or "listens" for fax tones. |
| 22 |  | Redial/Pause: Redials the most recently dialed number or inserts a 3-second pause in a fax number |
| 23 | | One-touch speed dial buttons: Accesses the first 20 speed dial numbers. Press a speed dial button once to select the speed dial number presented in the left column. Press the same speed dial button a second time to select the speed dial number in the right column. |

Load full-size paper

You can load full-size letter, A4, or legal paper into the input tray of the HP Fax.

 **CAUTION:** Make sure that the HP Fax is idle and silent when you load paper into the input tray. If it is servicing the print cartridges or otherwise engaged in a task, the paper stop inside the HP Fax might not be in place. You could push the paper too far forward, causing the HP Fax to eject blank pages.

 **TIP:** To help prevent rips, wrinkles, and curled or bent edges, store all paper flat in a resealable bag. If the paper is not stored properly, extreme changes in temperature and humidity might result in curled paper that does not work well in the HP Fax.

To load full-size paper

1. Slide the paper-width guide to its outermost position.

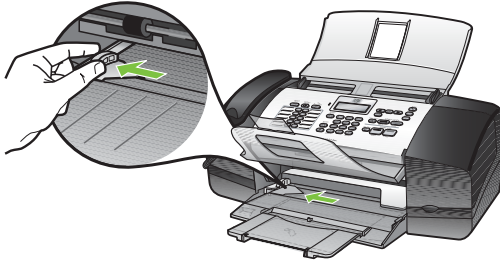

2. Flip the tray extender up toward you.

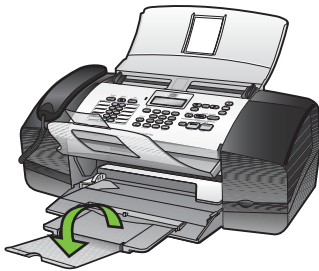

NOTE: When you use legal-size paper, leave the tray extender closed.

3. Tap a stack of paper on a flat surface to align the edges, and then check the paper for the following:
 - Make sure it is free of rips, dust, wrinkles, and curled or bent edges.
 - Make sure all the paper in the stack is the same size and type.

4. Insert the stack of paper into the input tray with the short edge forward and the print side down. Slide the stack of paper forward until it stops.

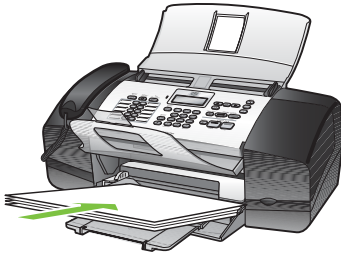

 **TIP:** If you are using letterhead, insert the top of the page first with the print side down. For more help on loading full-size paper and letterhead, refer to the diagram engraved in the base of the input tray.

5. Slide the paper-width guide inward until it stops at the edge of the paper. Do not overload the input tray; make sure the stack of paper fits within the input tray and is no higher than the top of the paper-width guide.



Load originals

You can copy or fax a single or multiple-page A4-, letter-, or legal-size document by placing it in the document feeder tray.

The document feeder tray holds a maximum of 20 sheets of letter- or A4-size paper, or it holds 15 sheets of legal-size paper.

To load an original in the document feeder tray

1. Load your original, with the print side down, into the document feeder tray. Place the pages so that the top edge of the document goes in first. Slide the media into the automatic document feeder until you hear a beep or see a message on the display indicating that the loaded pages were detected.

 **TIP:** For more help on loading originals in the automatic document feeder, refer to the diagram engraved in the document feeder tray.



2. Slide the width guides inward until they stop at the left and right edges of the media.

Change HP Fax settings

You can change the HP Fax settings from the control panel:

To change settings from the control panel

1. At the control panel, press the menu button for the function you are using (for example, **Copy Menu**).
2. To reach the option that you want to change, use one of the following methods:
 - Press a control-panel button, and then use the left or right arrow keys to adjust the value.
 - Select the option from the menu on the control-panel display.
3. Select the value that you want, and then press **OK**.

Send a basic fax

You can easily send a single- or multiple-page black-and-white fax by using the control panel.

 **NOTE:** If you need printed confirmation that your faxes were successfully sent, enable fax confirmation **before** sending any faxes.

 **TIP:** You can also send a fax manually from a phone or by using monitor dialing. These features allow you to control the pace of your dialing. They are also useful when you want to use a calling card to charge the call and you have to respond to tone prompts while dialing.

To send a basic fax from the control panel

1. Load your originals. For additional information, see [Load originals](#).
2. Enter the fax number by using the keypad, press **Speed Dial** or a one-touch speed dial button to select a speed dial, or press **Redial/Pause** to redial the last number dialed.

 **TIP:** To add a pause in the fax number you are entering, press **Redial/Pause**, or press the **Symbols (*)** button repeatedly, until a dash (-) appears on the display.

3. Press **START FAX Black**.

If the HP Fax detects an original loaded in the automatic document feeder, it sends the document to the number you entered.

 **TIP:** If the recipient reports issues with the quality of the fax you sent, you can try changing the resolution or contrast of your fax.

Set the answer mode

The answer mode determines how the HP Fax answers incoming calls.

- Select **Fax** mode if you want to receive faxes automatically. The HP Fax will answer the telephone, automatically detect fax tones, and receive a fax.
- Select **Tel** mode if you want to receive faxes manually. You must be available to respond in person to the incoming fax call or the HP Fax does not receive faxes. Press **START FAX Black** or **START FAX Color** to begin receiving the fax.
- Select **FaxTel** mode if you want the HP Fax to answer faxes automatically after a certain number of rings that are specified by the **Rings to Answer** setting. If the HP Fax does not sense a fax signal, it will ring 5 times in a different tone to tell you it may be a regular telephone call. If you do not pick up the handset, it will try again to receive a fax after several more rings.
- Select **AnswerMachine** mode if you have an answering machine connected directly to the port labeled 2-EXT on the back of your HP Fax. When a call comes in, the answering machine answers and listens. If it detects fax tones, it receives the fax; otherwise, the answering machine records the caller's message. If the answering machine is switched off or not connected to your HP Fax, the HP Fax will automatically attempt to receive a fax after several rings.

To select the answer mode via the control panel

- ▲ Press **Answer Mode** button until the desired mode displays.

Set up faxing for the HP Fax

After completing all the steps in the setup poster, use the instructions in this section to complete your fax setup. Keep your setup poster for later use.

In this section, you will learn how to set up the HP Fax so that faxing works successfully with equipment and services you might already have on the same phone line.

Set up faxing (parallel phone systems)

Before you begin setting up the HP Fax for faxing, determine which kind of phone system your country/region uses. The instructions for fax setup differ depending on whether you have a serial- or parallel-type phone system.

- If you do not see your country/region listed in the table below, you probably have a serial-type phone system. In a serial-type phone system, the connector type on your shared telephone equipment (modems, phones, and answering machines) does not allow a physical connection to the "2-EXT" port on the HP Fax. Instead, all equipment must be connected at the telephone wall jack.

 **NOTE:** In some countries/regions that use serial-type phone systems, the phone cord that came with the HP Fax might have an additional wall plug attached to it. This enables you to connect other telecom devices to the wall jack where you plug in the HP Fax.

- If your country/region is listed in the table below, you probably have a parallel-type telephone system. In a parallel-type phone system, you are able to connect shared telephone equipment to the phone line by using the "2-EXT" port on the back of the HP Fax.

 **NOTE:** If you have a parallel-type phone system, HP recommends you use the 2-wire phone cord supplied with the HP Fax to connect it to the telephone wall jack.

Table 1-1 Countries/regions with a parallel-type phone system

| | | |
|-----------|---------------|--------------|
| Argentina | Australia | Brazil |
| Canada | Chile | China |
| Colombia | Greece | India |
| Indonesia | Ireland | Japan |
| Korea | Latin America | Malaysia |
| Mexico | Philippines | Poland |
| Portugal | Russia | Saudi Arabia |
| Singapore | Spain | Taiwan |
| Thailand | USA | Venezuela |
| Vietnam | | |

If you are unsure which kind of telephone system you have (serial or parallel), check with your telephone company.

Serial-type fax setup

For information on setting up the HP Fax for faxing using a serial-type phone system, see the Fax Configuration Web site for your country/region.

| | |
|----------------------|--|
| Austria | www.hp.com/at/faxconfig |
| Germany | www.hp.com/de/faxconfig |
| Switzerland (French) | www.hp.com/ch/fr/faxconfig |
| Switzerland (German) | www.hp.com/ch/de/faxconfig |
| United Kingdom | www.hp.com/uk/faxconfig |
| Finland | www.hp.fi/faxconfig |
| Denmark | www.hp.dk/faxconfig |
| Sweden | www.hp.se/faxconfig |
| Norway | www.hp.no/faxconfig |
| Netherlands | www.hp.nl/faxconfig |
| Belgium (Dutch) | www.hp.be/nl/faxconfig |
| Belgium (French) | www.hp.be/fr/faxconfig |
| Portugal | www.hp.pt/faxconfig |
| Spain | www.hp.es/faxconfig |
| France | www.hp.com/fr/faxconfig |
| Ireland | www.hp.com/ie/faxconfig |
| Italy | www.hp.com/it/faxconfig |

2 Use the HP Fax

- [Control panel menus](#)
- [Use control panel menus](#)
- [Control-panel message types](#)
- [Text and symbols](#)
- [Set up speed-dial entries](#)
- [Select print media](#)

Control panel menus

| Setup Menu | | | |
|--|---|--|--|
| <p>1. Print Report</p> <ul style="list-style-type: none"> <input type="checkbox"/> 1. Fax Confirmation <input type="checkbox"/> 2. Image on Fax Send Report <input type="checkbox"/> 3. Fax Error Report <input type="checkbox"/> 4. Self-Test Report <input type="checkbox"/> 5. Last Transaction <input type="checkbox"/> 6. Fax Log <input type="checkbox"/> 7. Speed Dial List <input type="checkbox"/> 8. Caller ID Report <input type="checkbox"/> 9. Junk Fax List <input type="checkbox"/> 0. Reprint Faxes in Memory | <p>4. Advanced Fax Setup</p> <ul style="list-style-type: none"> <input type="checkbox"/> 1. Distinctive Ring <input type="checkbox"/> 2. Busy Redial <input type="checkbox"/> 3. No Answer Redial <input type="checkbox"/> 4. Automatic Reduction <input type="checkbox"/> 5. Backup Fax Reception <input type="checkbox"/> 6. Error Correction Mode <input type="checkbox"/> 7. Fax Speed <input type="checkbox"/> 8. Fax Forwarding (Black Only) | | |
| <p>2. Speed Dial Setup</p> <ul style="list-style-type: none"> <input type="checkbox"/> 1. Individual Speed Dial <input type="checkbox"/> 2. Group Speed Dial <input type="checkbox"/> 3. Delete Speed Dial <input type="checkbox"/> 4. Print Speed Dial List | <p>5. Tools</p> <ul style="list-style-type: none"> <input type="checkbox"/> 1. Clean Print Cartridge <input type="checkbox"/> 2. Align Print Cartridge <input type="checkbox"/> 3. Date and Time <input type="checkbox"/> 4. Restore Factory Defaults <input type="checkbox"/> 5. Reprint Faxes in Memory <input type="checkbox"/> 6. Run Fax Test <input type="checkbox"/> 7. Clear Fax Log | | |
| <p>3. Basic Fax Setup</p> <ul style="list-style-type: none"> <input type="checkbox"/> 1. Fax Header <input type="checkbox"/> 2. Rings to Answer <input type="checkbox"/> 3. Fax Paper Size <input type="checkbox"/> 4. Rings and Beep Volume <input type="checkbox"/> 5. Phone Line, Monitor Volume <input type="checkbox"/> 6. Tone and Pulse Dialing <input type="checkbox"/> 7. Junk Fax Blocker Setup | <p>6. Preferences</p> <ul style="list-style-type: none"> <input type="checkbox"/> 1. Set Language and Country/Region <input type="checkbox"/> 2. Set Scroll Speed <input type="checkbox"/> 3. Set Prompt Delay Time | | |
| Fax Menu | Copy Menu | | |
| <ul style="list-style-type: none"> <input type="checkbox"/> Enter Number <input type="checkbox"/> Resolution | <table border="1"> <tbody> <tr> <td style="vertical-align: top;"> <ul style="list-style-type: none"> <input type="checkbox"/> Number of Copies <input type="checkbox"/> Reduce/Enlarge </td> <td style="vertical-align: top;"> <ul style="list-style-type: none"> <input type="checkbox"/> Paper Type <input type="checkbox"/> Lighter/Darker </td> </tr> </tbody> </table> | <ul style="list-style-type: none"> <input type="checkbox"/> Number of Copies <input type="checkbox"/> Reduce/Enlarge | <ul style="list-style-type: none"> <input type="checkbox"/> Paper Type <input type="checkbox"/> Lighter/Darker |
| <ul style="list-style-type: none"> <input type="checkbox"/> Number of Copies <input type="checkbox"/> Reduce/Enlarge | <ul style="list-style-type: none"> <input type="checkbox"/> Paper Type <input type="checkbox"/> Lighter/Darker | | |

(continued)

| Fax Menu | Copy Menu |
|---|---|
| <input type="checkbox"/> Lighter/Darker <input type="checkbox"/> How to Fax <input type="checkbox"/> Set New Defaults | <input type="checkbox"/> Copy Quality <input type="checkbox"/> Enhancements <input type="checkbox"/> Copy Paper Size <input type="checkbox"/> Set New Defaults |

Use control panel menus

The following sections provide a quick reference to top-level menus that appear on the control-panel display. To display a menu, press the menu button for the function you want to use.

- **Fax menu:** Menu options include:
 - Modifying resolution
 - Lightening/darkening
 - Sending delayed faxes
 - Setting up new defaults
- **Copy menu:** Menu options include:
 - Selecting copy quantities
 - Reducing/enlarging
 - Selecting media type and size

Control-panel message types

| Message type | Description |
|------------------|--|
| Status messages | Status messages reflect the current state of the HP Fax. They inform you of normal operation and require no action to clear them. They change as the state of the HP Fax changes. Whenever the HP Fax is ready, not busy, and has no pending warning messages, the display shows date, time, and the answer mode. |
| Warning messages | Warning messages inform you of events that require your attention, but they do not prevent the HP Fax from operating. An example of a warning message is a low ink warning. These messages appear until you resolve the condition. |
| Error messages | <p>Error messages communicate that some action must be performed, such as adding media or clearing a media jam. These messages are usually accompanied by a blinking red Attention light. Take the appropriate action to continue printing.</p> <p>If the error message shows an error code, unplug the HP Fax, and then plug it in again. In most situations, this action solves the problem. If the message persists, your HP Fax might need service. For more information, see Support and warranty.</p> <p>NOTE: The faxes stored in memory are not deleted when you unplug the power cord.</p> |

(continued)

| Message type | Description |
|-------------------------|---|
| Critical error messages | <p>Critical error messages inform you of a HP Fax failure. Some of these messages can be cleared by unplugging the power cord, and plugging it back in again. If a critical error persists, service is required. For more information, see Support and warranty.</p> <p>NOTE: The faxes stored in memory are not deleted when you unplug the power cord.</p> |

Text and symbols

You can use the keypad on the control panel to enter text and symbols.

You can also enter symbols from the keypad when you dial a fax or phone number. When the HP Fax dials the number, it interprets the symbol and responds accordingly. For example, if you enter a dash in the fax number, the HP Fax will pause before dialing the remainder of the number. A pause is useful if you need to gain access to an outside line before dialing the fax number.

 **NOTE:** If you want to enter a symbol in your fax number, such as a dash, you need to enter the symbol by using the keypad.

Type numbers and text on the control-panel keypad

You can enter text or symbols by using the keypad on the control panel.

After you are done entering text, press **OK** to store your entry.

To enter text

1. Press the keypad numbers that correspond to the letters of a name. For example, the letters a, b, and c correspond to the number 2, as shown on the button below.



 **TIP:** Press a button multiple times to see the available characters. Depending on your language and country/region setting, other characters might be available in addition to the ones shown on the keypad.

2. After the correct letter appears, wait for the cursor to advance automatically to the right, or press the right arrow button. Press the number that corresponds to the next letter in the name. Press the button multiple times until the correct letter appears. The first letter of a word is automatically set to uppercase.

To enter a space, pause, or symbol

- To insert a space, press **Space**.
- To enter a pause, press **Redial/Pause**. A dash appears in the number sequence.
- To enter a symbol, such as **@**, press the **Symbols** button repeatedly to scroll through the list of available symbols: at (**@**), period (**.**), underscore (**_**), dash (**-**), ampersand (**&**), slash (**/**), colon (**:**), semicolon (**;**), comma (**,**), question (**?**), back slash (****), asterisk (*****), parentheses (**()**), apostrophe (**'**), equals (**=**), plus (**+**), number sign (**#**), exclamation (**!**), percent (**%**), and quotation mark (**"**).

To erase a letter, number, or symbol

- ▲ If you make a mistake, press the left arrow button to clear it, and then make the correct entry.

Available symbols for dialing fax numbers

To enter a symbol, such as *****, press **Symbols** repeatedly to scroll through the list of symbols. The following table provides the symbols that you can use in a fax or phone number sequence, fax header information, and speed-dial entries.

| Available symbols | Description | Available when entering |
|-------------------|--|---|
| * | Displays an asterisk symbol when required for dialing. | Fax header name, speed-dial names, speed-dial numbers, fax or phone numbers, and monitor dial entries |
| - | When auto-dialing, the HP Fax enters a pause in the number sequence. | Fax header name, fax header number, speed-dial names, speed-dial numbers, and fax or phone numbers |
| () | Displays a left or right parenthesis to separate numbers, such as area codes, for easier reading. These symbols do not affect dialing. | Fax header name, fax header number, speed-dial names, speed-dial numbers, and fax or phone numbers |
| W | When auto-dialing, W causes the HP Fax to wait for a dial tone before continuing to dial. | Speed-dial numbers and fax or phone numbers |
| R | During auto-dialing, the R functions the same as a Flash button on your telephone. | Speed-dial numbers and fax or phone numbers |
| + | Displays a plus symbol. This symbol does not affect dialing. | Fax header name, fax header number, speed-dial names, speed-dial numbers, and fax or phone numbers |

Set up speed-dial entries

You can set up frequently used fax numbers as speed-dial entries. This lets you dial those numbers quickly by using the control panel. The first 20 entries for each of these

destinations are associated with the 10 dual-purpose speed-dial buttons on the control panel.

- [Set up fax numbers as speed-dial entries or groups](#)
- [Print and view a list of speed-dial entries](#)

Set up fax numbers as speed-dial entries or groups

You can store fax numbers or groups of fax numbers as speed-dial entries. Speed-dial entries 1 through 20 are associated with the corresponding ten speed-dial buttons on the control panel.

For information about printing a list of the speed-dial entries that are set up, see [Print and view a list of speed-dial entries](#).

- [Set up speed-dial entries](#)
- [Set up a speed-dial group](#)

Set up speed-dial entries

Control panel: Press **Setup**, and then select the **Speed Dial Setup** option.

- To add or change an entry: Select **Individual Speed Dial** or **Group Speed Dial** and press the arrow keys to move to an unused entry number, or type a number on the keypad. Type the fax number, and then press **OK**. Include any pauses or other required numbers, such as an area code, an access code for numbers outside a PBX system (usually a 9 or 0), or a long-distance prefix. Type the name, and then press **OK**.
- To delete one entry or all entries: Select **Delete Speed Dial**, press the arrow keys to highlight the speed-dial entry that you want to delete, and then press **OK**.

Set up a speed-dial group

If you send information to the same group of fax numbers on a regular basis, you can set up a speed-dial entry for a group in order to simplify the task. The speed-dial entry for a group can be associated with a speed-dial button on the control panel.

A group member must be a member of the speed-dial list before you can add the member to a speed-dial group. You can add up to 48 fax numbers to each group (with up to 50 characters for each fax number).

Control panel: Press the **Setup** button, and then select the **Speed Dial Setup** option.

- To add a group: Select **Group Speed Dial**, select an unassigned speed-dial entry, and then press **OK**. Use the arrow keys to highlight a speed-dial entry, and then press **OK** to select it. Repeat this step to add additional speed-dial entries to this group. Use the keypad to enter a group speed-dial name, and then press **OK**. Follow any prompts that might occur.
- To add entries to a group: Select **Group Speed Dial**, select the group speed-dial entry that you want to change, and then press **OK**. Use the arrow keys to highlight a speed-dial entry, and then press **OK** to select it. Repeat this step to add additional speed-dial entries to this group. Follow any prompts that might occur.
- To delete a group: Select **Delete Speed Dial**, press the arrow keys to highlight the speed-dial entry that you want to delete, and then press **OK**.

Print and view a list of speed-dial entries

You can print or view a list of all of the speed-dial entries that have been set up. Each entry in the list contains the following information:

- Speed-dial number (the first ten entries correspond to the ten speed-dial buttons on the control panel)
- Name associated with the fax number or group of fax numbers
- For the fax speed-dial list, the fax number (or all of the fax numbers for a group)

Select print media

The HP Fax is designed to work well with most types of office media. It is best to test a variety of print media types before buying large quantities. Use HP media for optimum print quality. Visit the HP Web site at www.hp.com for more information about HP media.

Tips for selecting and using print media

For the best results, observe the following guidelines.

- Always use media that conforms to the HP Fax specifications. For more information, see [Understand specifications for supported media](#).
- Load only one type of media at a time into a tray.
- Load media print-side down and aligned against the right and back edges of the tray. For more information, see [Load full-size paper](#).
- Do not overload the tray. For more information, see [Understand specifications for supported media](#).
- To prevent jams, poor print quality, and other printing problems, avoid the following media:
 - Multipart forms
 - Media that is damaged, curled, or wrinkled
 - Media with cutouts or perforations
 - Media that is heavily textured, embossed, or does not accept ink well
 - Media that is too lightweight or stretches easily

Photo media

- Use the **Best** mode to copy images/embedded pictures. Note that in this mode, copying takes longer.
- Remove each sheet as it copies and set it aside to dry. Allowing wet media to stack up may cause smearing.

Transparencies

- Insert transparencies with the rough side down and the adhesive strip pointing towards the back of the device.
- Use the **Normal** mode to copy transparencies. This mode provides longer drying time and ensures that the ink dries completely before the next page is delivered to the output tray.
- Remove each sheet as it copies and set it aside to dry. Allowing wet media to stack up may cause smearing.

Understand specifications for supported media

Use the following tables to determine the correct media to use with your HP Fax, and determine what features will work with your media.

- [Understand supported sizes](#)
- [Understand supported media types and weights](#)

Understand supported sizes

| Type | Size |
|---------------------|---|
| Paper | Letter: 216 x 279 mm (8.5 x 11 inches) A4: 210 x 297 mm (8.3 x 11.7 inches) Legal: 216 x 356 mm (8.5 x 14 inches) B5–JIS: 182 x 257 mm (7.2 x 10.1 inches) |
| Transparency film | Letter: 216 x 279 mm (8.5 x 11 inches) A4: 210 x 297 mm (8.3 x 11.7 inches) |
| Premium photo paper | Letter: 216 x 280 mm (8.5 x 11 inches) A4: 210 x 297 mm (8.3 x 11.7 inches) |

Understand supported media types and weights

| Type | Paper weight | Input tray* | Output tray** | Document feeder tray |
|---------------------------|-----------------------------|-----------------------------|----------------------------|----------------------|
| Plain paper | 16 to 24 lb. (60 to 90 gsm) | up to 100 (16 lb. paper) | up to 20 (16 lb. paper) | up to 20 |
| Legal paper | 20 to 24 lb. (75 to 90 gsm) | up to 100 (16 lb. paper) | up to 20 (16 lb. paper) | up to 15 |
| Transparency film | N/A | 25 | up to 10 | N/A |
| 8.5 x 11 inch photo paper | N/A | 40 | 20 | N/A |

* Maximum capacity. The input tray has a maximum input stack height capacity of 10 mm.

** Output tray capacity is affected by the type of paper and the amount of ink you are using. HP recommends emptying the output tray frequently.

Set minimum margins

| | Top (leading edge) | Bottom (trailing edge) | Left and Right margins |
|---------------------------------|----------------------|------------------------|------------------------|
| U.S. (Letter, Legal, Executive) | 1.5 mm (0.06 inches) | 12.7 mm (0.50 inches) | 6.4 mm (0.25 inches) |
| ISO (A4, A5) and JIS (B5) | 1.8 mm (0.07 inches) | 12.7 mm (0.50 inches) | 3.2 mm (0.13 inches) |

3 Fax

You can use the HP Fax to send and receive faxes, including color faxes. You can schedule faxes to be sent at a later time and set up speed-dials to send faxes quickly and easily to frequently used numbers. From the control panel, you can also set a number of fax options, such as resolution and the contrast between lightness and darkness on the faxes you send.

 **NOTE:** Before you begin faxing, make sure you have set up the HP Fax properly for faxing.

You can verify the fax is set up correctly by running the fax setup test from the control panel. To run the fax test, press **Setup**, select **Tools**, select **Run fax test**, and then press **OK**.

- [Send a fax](#)
- [Receive a fax](#)
- [Change fax settings](#)
- [Fax over the Internet](#)
- [Cancel a fax](#)

Send a fax

You can send a fax in a variety of ways. Using the control panel, you can send a black-and-white or color fax. You can also initiate a fax manually from an external phone. This allows you to speak with the recipient before sending the fax.

- [Send a fax manually from a phone](#)
- [Send a fax using monitor dialing](#)
- [Send a fax from memory](#)
- [Schedule a fax to send later](#)
- [Send a fax to multiple recipients](#)
- [Send a color original or image/embedded picture fax](#)
- [Change the fax resolution and Lighter/Darker settings](#)
- [Send a fax in Error Correction Mode](#)

Send a fax manually from a phone

Sending a fax manually allows you to make a phone call and talk with the recipient before you send the fax. This is useful if you want to inform the recipient that you are going to send them a fax before sending it. When you send a fax manually, you can hear the dial tones, telephone prompts, or other sounds through the handset on your telephone. This makes it easy for you to use a calling card to send your fax.

Depending on how the recipient has their fax machine set up, the recipient might answer the phone, or the fax machine might take the call. If a person answers the phone, you can speak with the recipient before sending the fax. If a fax machine answers the call,

you can send the fax directly to the fax machine when you hear the fax tones from the receiving fax machine.

To initiate a fax manually from an external phone

1. Load your originals. For additional information, see [Load originals](#).
2. Dial the number by using the keypad on the phone that is connected to the HP Fax.

 **NOTE:** Do not use the keypad on the control panel of the HP Fax when manually sending a fax. You must use the keypad on your phone to dial the recipient's number.

3. If the recipient answers the telephone, you can engage in a conversation before sending your fax.

 **NOTE:** If a fax machine answers the call, you will hear fax tones from the receiving fax machine. Proceed to the next step to transmit the fax.

4. When you are ready to send the fax, press **START FAX Black** or **START FAX Color**.

 **NOTE:** If prompted, select **Send Fax**, and then press **START FAX Black** or **START FAX Color** again.

If you were speaking with the recipient before sending the fax, inform the recipient that they should press **Start** on their fax machine after they hear fax tones.

The telephone line is silent while the fax is transmitting. At this point, you can hang up the telephone. If you want to continue speaking with the recipient, remain on the line until the fax transmission is complete.

To send a fax manually using the attached handset

1. Load your originals print side down and top first in the center of the document feeder tray.
2. Pick up the handset that is attached to the HP Fax and dial the number by using the keypad on the control panel.
3. If the recipient answers the telephone, you can engage in a conversation before sending your fax.

 **NOTE:** If a fax machine answers the call, you will hear fax tones from the receiving fax machine. Proceed to the next step to transmit the fax.

4. Once you are ready to send the fax, press **START FAX Black** or **START FAX Color**.

 **NOTE:** If prompted, select **Send Fax**, and then press **START FAX Black** or **START FAX Color** again.

If you were speaking with the recipient before sending the fax, inform the recipient that they should press **Start** on their fax machine after they hear fax tones.

The telephone line is silent while the fax is transmitting. At this point, you can hang up the telephone. If you want to continue speaking with the recipient, remain on the line until the fax transmission is complete.

Send a fax using monitor dialing

Monitor dialing allows you to dial a number from the control panel as you would dial a regular telephone. When you send a fax using monitor dialing, you can hear the dial tones, telephone prompts, or other sounds through the speakers on the HP Fax. This enables you to respond to prompts while dialing, as well as control the pace of your dialing.

 **TIP:** If you do not enter your calling card PIN fast enough, the HP Fax might start sending fax tones too soon and cause your PIN not to be recognized by the calling card service. If this is the case, you can create a speed dial entry to store the PIN for your calling card.

 **NOTE:** Make sure the volume is turned on, or you will not hear a dial tone.

To send a fax using monitor dialing from the control panel

1. Load your originals. For additional information, see [Load originals](#).
2. Press **START FAX Black** or **START FAX Color**.
If the HP Fax detects an original loaded in the automatic document feeder, you will hear a dial tone.
3. When you hear the dial tone, enter the number by using the keypad on the control panel.
4. Follow any prompts that might occur.

 **TIP:** If you are using a calling card to send a fax and you have your calling card PIN stored as a speed dial, when prompted to enter your PIN, press **Speed Dial** or a one-touch speed dial button to select the speed dial entry where you have your PIN stored.

Your fax is sent when the receiving fax machine answers.

Send a fax from memory

You can scan a black-and-white fax into memory and then send the fax from memory. This feature is useful if the fax number you are trying to reach is busy or temporarily unavailable. The HP Fax scans the originals into memory and sends them once it is able to connect to the receiving fax machine. After the HP Fax scans the pages into memory, you can immediately remove the originals from the document feeder tray.

 **NOTE:** You can only send a black-and-white fax from memory.

To send a fax from memory

1. Load your originals print side down into the document feeder tray.
2. In the Fax area, press **Fax Menu**.
The **Enter Number** prompt appears.
3. Enter the fax number by using the keypad, press **Speed Dial** or a one-touch speed dial button to select a speed dial, or press **Redial/Pause** to redial the last number dialed.
4. In the Fax area, press **Fax Menu** repeatedly until **How to Fax** appears.

5. Press **▶** until **Scan & Fax** appears, and then press **OK**.
6. Press **START FAX Black**.
The HP Fax scans the originals into memory and sends the fax when the receiving fax machine is available.

Schedule a fax to send later

You can schedule a black-and-white fax to be sent within the next 24 hours. This enables you to send a black-and-white fax late in the evening, when phone lines are not as busy or phone rates are lower, for example. The HP Fax automatically sends your fax at the specified time.

You can only schedule one fax to be sent at a time. You can continue to send faxes normally, however, while a fax is scheduled.

 **NOTE:** You can only send faxes in black and white due to memory limitations.

To schedule a fax from the control panel

1. Load your originals print side down into the document feeder tray.
2. In the Fax area, press **Fax Menu** repeatedly until **How to Fax** appears.
3. Press **▶** until **Send Fax Later** appears, and then press **OK**.
4. Enter the send time by using the numeric keypad, and then press **OK**. If prompted, press **1** for **AM**, or **2** for **PM**.
5. Enter the fax number by using the keypad, press **Speed Dial** or a one-touch speed dial button to select a speed dial, or press **Redial/Pause** to redial the last number dialed.
6. Press **START FAX Black**.
The HP Fax scans all pages and the scheduled time appears on the display. The fax is sent at the scheduled time.

To cancel a scheduled fax

1. In the Fax area, press **Fax Menu** repeatedly until **How to Fax** appears.
2. Press **▶** until **Send Fax Later** appears, and then press **OK**.
If there is a fax already scheduled, the **Cancel** prompt appears on the display.
3. Press **1** to select **Yes**.

 **NOTE:** You can also cancel the scheduled fax by pressing **Cancel** on the control panel when the scheduled time is visible on the display.

Send a fax to multiple recipients

You can send a fax to multiple recipients without first setting up a group speed dial.

 **NOTE:** The list of recipients you specify for this fax is not saved and only works for sending faxes in black. If you intend to send other faxes to the same recipient list, you should create a group speed dial list. For more information, see [Set up fax numbers as speed-dial entries or groups](#)

To send a fax to multiple recipients without using group speed dial

1. Press **Fax Menu**, select **How to Fax**, and then select **Broadcast Fax**.
2. Enter a fax number by using the keypad, or use the arrow keys to access speed dials.
3. At the **Enter Another?** prompt, do one of the following:
 - If you want to add another, press **Yes**, and then repeat step 2 for each number.
 - If you are done, press **No**.



NOTE: You can add up to 20 individual fax numbers.

4. Press **START FAX Black**.
5. When prompted, load your originals print side down and top first in the center of the document feeder tray. For additional information, see [Load originals](#).
6. Press **START FAX Black** again.

You can send a fax to multiple recipients at once by grouping individual speed dial entries into group speed dial entries.

To send a fax to multiple recipients using group speed dial

1. Load your originals print side down into the document feeder tray.
2. Press **Speed Dial** repeatedly, until the appropriate group speed dial entry appears.



TIP: You can also scroll through the speed dial entries by pressing ◀ or ▶, or you can select a speed dial entry by entering its speed dial code using the keypad on the control panel.

3. Press **START FAX Black**.

If the HP Fax detects an original loaded in the automatic document feeder, it sends the document to each number in the group speed dial entry.



NOTE: You can only use group speed dial entries to send faxes in black and white, because of memory limitations. The HP Fax scans the fax into memory then dials the first number. When a connection is made, it sends the fax and dials the next number. If a number is busy or not answering, the HP Fax follows the settings for **Busy Redial** and **No Answer Redial**. If a connection cannot be made, the next number is dialed and an error report is generated.

Send a color original or image/embedded picture fax

You can fax a color original or image/embedded picture from the HP Fax. If it determines that the recipient's fax machine only supports black-and-white faxes, the fax is sent in black and white.

HP recommends that you use only color originals for color faxing.

To send a color original or image/embedded picture fax from the control panel

1. Load your originals print side down into the document feeder tray.
2. In the Fax area, press **Fax Menu**.
The **Enter Number** prompt appears.

3. Enter the fax number by using the keypad, press **Speed Dial** or a one-touch speed dial button to select a speed dial, or press **Redial/Pause** to redial the last number dialed.
4. Press **START FAX Color**.
If the HP Fax detects an original loaded in the automatic document feeder, it sends the document to the number you entered.

 **NOTE:** If the recipient's fax machine only supports black-and-white faxes, the HP Fax automatically sends the fax in black and white. A message appears after the fax has been sent indicating that the fax was sent in black and white. Press **OK** to clear the message.

Change the fax resolution and Lighter/Darker settings

You can change the **Resolution** and **Lighter / Darker** settings for documents that you are faxing.

 **NOTE:** These settings do not affect copy settings. Copy resolution and lightness/darkness are set independently from fax resolution and lightness/darkness.

- [Change the fax resolution](#)
- [Change the Lighter / Darker setting](#)
- [Set new default settings](#)

Change the fax resolution

The **Resolution** setting affects the transmission speed and quality of faxed black-and-white documents. If the receiving fax machine does not support the resolution you have chosen, the HP Fax sends faxes at the highest resolution supported by the receiving fax machine.

 **NOTE:** You can only change the resolution for faxes that you are sending in black and white. The HP Fax sends all color faxes using **Fine** resolution.

The following resolution settings are available for sending faxes: **Fine**, **Very Fine**, **Photo**, and **Standard**.

- **Fine:** provides high-quality text suitable for faxing most documents. This is the default setting. When sending faxes in color, the HP Fax always uses the **Fine** setting.
- **Very Fine:** provides the best quality fax when you are faxing documents with very fine detail. If you choose **Very Fine**, be aware that the faxing process takes longer to complete and you can only send black-and-white faxes using this resolution. If you send a color fax, it will be sent using **Fine** resolution instead.
- **Photo:** provides the best quality fax when sending images/embedded pictures in black and white. If you choose **Photo**, be aware that the faxing process takes longer to complete. When faxing images/embedded pictures in black and white, HP recommends that you choose **Photo**.
- **Standard:** provides the fastest possible fax transmission with the lowest quality.

When you exit the Fax menu, this option returns to the default setting unless you set your changes as the default.

To change the resolution from the control panel

1. Load your originals print side down into the document feeder tray.
2. In the Fax area, press **Fax Menu**.
The **Enter Number** prompt appears.
3. Enter the fax number by using the keypad, press **Speed Dial** or a one-touch speed dial button to select a speed dial, or press **Redial/Pause** to redial the last number dialed.
4. In the Fax area, press **Fax Menu** repeatedly until **Resolution** appears.
5. Press ► to select a resolution setting, and then press **OK**.
6. Press **START FAX Black**.
If the HP Fax detects an original loaded in the automatic document feeder, it sends the document to the number you entered.

Change the Lighter / Darker setting

You can change the contrast of a fax to be darker or lighter than the original. This feature is useful if you are faxing a document that is faded, washed out, or handwritten. You can darken the original by adjusting the contrast.

 **NOTE:** The **Lighter / Darker** setting applies to black-and-white faxes only, not color faxes.

When you exit the Fax menu, this option returns to the default setting unless you set your changes as the default.

To change the Lighter / Darker setting from the control panel

1. Load your originals print side down into the document feeder tray.
2. In the Fax area, press **Fax Menu**.
The **Enter Number** prompt appears.
3. Enter the fax number by using the keypad, press **Speed Dial** or a one-touch speed dial button to select a speed dial, or press **Redial/Pause** to redial the last number dialed.
4. In the Fax area, press **Fax Menu** repeatedly until **Lighter / Darker** appears.
5. Press ◀ to lighten the fax or press ► to darken it, and then press **OK**.
The indicator moves to the left or right as you press an arrow button.
6. Press **START FAX Black**.
If the HP Fax detects an original loaded in the automatic document feeder, it sends the document to the number you entered.

Set new default settings

You can change the default value for the **Resolution** and **Lighter / Darker** settings through the control panel.

To set new default settings from the control panel

1. Make changes to the **Resolution** and **Lighter / Darker** settings.
2. In the Fax area, press **Fax Menu** repeatedly until **Set New Defaults** appears.
3. Press ► until **Yes** appears, and then press **OK**.

Send a fax in Error Correction Mode

Error Correction Mode (ECM) prevents loss of data due to poor phone lines by detecting errors that occur during transmission and automatically requesting retransmission of the erroneous portion. Phone charges are unaffected, or might even be reduced, on good phone lines. On poor phone lines, ECM increases sending time and phone charges, but sends the data much more reliably. The default setting is **On**. Turn ECM off only if it increases phone charges substantially, and you can accept poorer quality in exchange for reduced charges.

Before turning the ECM setting off, consider the following. If you turn ECM off

- The quality and transmission speed of faxes you send and receive are affected.
- The **Fax Speed** is automatically set to **Medium**.
- You will no longer be able to send or receive faxes in color.

To change the ECM setting from the control panel

1. Press **Setup**.
2. Select **Advanced Fax Setup** and then select **Error Correction Mode**.
3. Press **▶** to select **On** or **Off**.
4. Press **OK**.

Receive a fax

You can receive faxes automatically or manually. Press the **Answer Mode** button to select the desired mode. If you select **Tel** mode, you must receive faxes manually. If you select **FaxTel** mode, the HP Fax automatically answers incoming calls and receives faxes after the number of rings that are specified by the **Rings to Answer** setting. If you select **Fax** or **AnswerMachine** modes, the HP Fax will answer the telephone, automatically detect fax tones, and receive a fax. You must have an answering machine connected directly to the port labeled 2-EXT on the back of your HP Fax for **AnswerMachine** mode.

If you receive a legal-size fax and the HP Fax is not currently set to use legal-size paper, the HP Fax reduces the fax so that it fits on the paper that is loaded. If you have disabled the **Automatic Reduction** feature, the HP Fax prints the fax on two pages.

- [Receive a fax manually](#)
- [Set up backup fax reception](#)
- [Reprint received faxes from memory](#)
- [Poll to receive a fax](#)
- [Forward faxes to another number](#)
- [Set the paper size for received faxes](#)
- [Set automatic reduction for incoming faxes](#)
- [Block junk fax numbers](#)

Receive a fax manually

When you are on the phone, the person you are speaking with can send you a fax while you are still connected. This is referred to as manual faxing. Use the instructions in this section to receive a manual fax.

 **NOTE:** You can pick up the handset to talk or listen for fax tones.

You can receive faxes manually from a phone that is:

- Directly connected to the HP Fax (on the 2-EXT port)
- On the same phone line, but not directly connected to the HP Fax

To receive a fax manually

1. Make sure the HP Fax is plugged in and you have paper loaded in the input tray.
2. Remove any originals from the document feeder tray.
3. Set the **Rings to Answer** setting to a high number to allow you to answer the incoming call before the HP Fax answers. Or, select **Tel** mode so that the HP Fax does not automatically answer incoming calls.
4. If you are currently on the phone with the sender, instruct the sender to press **Start** on their fax machine.
5. When you hear fax tones from a sending fax machine, do the following:
 - a. Press **START FAX Black** or **START FAX Color** on the control panel.
 - b. When prompted, select **Fax Receive**.
 - c. After the HP Fax begins to receive the fax, you can hang up the phone or remain on the line. The phone line is silent during fax transmission.

Set up backup fax reception

Depending on your preference and security requirements, you can set up the HP Fax to store all the faxes it receives, only the faxes it receives while the HP Fax is in an error condition, or none of the faxes it receives.

The following **Backup Fax Reception** modes are available:

| | |
|----------------------|--|
| On | <p>The default setting. When Backup Fax Reception is On, the HP Fax stores all received faxes in memory. This enables you to reprint the most recently printed faxes if they are still saved in memory.</p> <p>NOTE: When HP Fax memory is low, it overwrites the oldest, printed faxes as it receives new faxes. If the memory becomes full of unprinted faxes, the HP Fax stops answering incoming fax calls.</p> <p>NOTE: If you receive a fax that is too large, such as a very detailed color image/embedded picture, it might not be stored in memory due to memory limitations.</p> |
| On Error Only | <p>Causes the HP Fax to store faxes in memory only if an error condition exists that prevents the HP Fax from printing the faxes (for example, if the HP Fax runs out of paper). The HP Fax continues to store incoming faxes as long as there is memory available. (If the memory becomes full, the HP Fax stops answering incoming fax calls.) When the error condition is resolved, the faxes stored in memory print automatically, and then they are deleted from memory.</p> |
| Off | <p>Faxes are never stored in memory. For example, you might want to turn off Backup Fax Reception for security purposes. If an error condition occurs that prevents the HP Fax from printing (for example, the HP Fax runs out of paper), the HP Fax stops answering incoming fax calls.</p> |

To set backup fax reception from the control panel

1. Press **Setup**.
2. Select **Advanced Fax Setup**, and then select **Backup Fax Reception**.
3. Press ► to select **On**, **On Error Only**, or **Off**.
4. Press **OK**.

Reprint received faxes from memory

If you set the **Backup Fax Reception** mode to **On**, the received faxes are stored in memory, whether the HP Fax has an error condition or not.

 **NOTE:** After the memory becomes full, the oldest, printed faxes are overwritten as new faxes are received. If all the stored faxes are unprinted, the HP Fax does not receive any fax calls until you print or delete the faxes from memory. You might also want to delete the faxes in memory for security or privacy purposes.

You can reprint the most recently printed faxes, if they are still in memory. For example, you might need to reprint your faxes if you lost the copy of your last printout.

To reprint faxes in memory from the control panel

1. Make sure you have paper loaded in the input tray.
2. Do one of the following:
 - Press **Setup**, select **Tools**, and then select **Reprint Faxes in Memory**.
 - Press **Reports**, and then select **Reprint Faxes in Memory**.

The faxes are printed in the reverse order from which they were received with the most recently received fax printed first, and so on.

3. If you want to stop reprinting the faxes in memory, press **Cancel**.

To delete all the faxes in memory from the control panel

1. Press **Setup**.
2. Select **Tools**, and then select **Clear Fax Log**.

 **NOTE:** All faxes stored in memory, including all unprinted or unsent faxes, are deleted.

Poll to receive a fax

Polling allows the HP Fax to ask another fax machine to send a fax that it has in its queue. When you use the **Poll to Receive** feature, the HP Fax calls the designated fax machine and requests the fax from it. The designated fax machine must be set for polling and have a fax ready to send.

 **NOTE:** The HP Fax does not support polling pass codes. Polling pass codes are a security feature that require the receiving fax machine to provide a pass code to the HP Fax it is polling in order to receive the fax. Make sure the HP Fax you are polling does not have a pass code set up (or has not changed the default pass code) or the HP Fax will not be able to receive the fax.

To set up poll to receive a fax from the control panel

1. In the Fax area, press **Fax Menu** repeatedly until **How to Fax** appears.
2. Press **▶** until **Poll to Receive** appears, and then press **OK**.
3. Enter the fax number of the other fax machine.
4. Press **START FAX Black** or **START FAX Color**.



NOTE: If you press **START FAX Color** but the sender sent the fax in black and white, the HP Fax prints the fax in black and white.

Forward faxes to another number

You can set up the HP Fax to forward your faxes to another fax number. A received color fax is forwarded in black and white.

HP recommends that you verify the number you are forwarding to is a working fax line. Send a test fax to make sure the fax machine is able to receive your forwarded faxes.

To forward faxes from the control panel

1. Press **Setup**.
2. Select **Advanced Fax Setup**, and then select **Fax Forwarding Black Only**.
3. Press **▶** until **On-Forward** or **On-Print & Forward** appears, and then press **OK**.
 - Choose **On-Forward** if you want to forward the fax to another number without printing a backup copy on the HP Fax.



NOTE: If the HP Fax is not able to forward the fax to the designated fax machine (for example, if it is not turned on), the HP Fax prints the fax. If you set up the HP Fax to print error reports for received faxes, it will also print an error report.

- Choose **On-Print & Forward** to print a backup copy of your received fax while forwarding the fax to another number.
4. At the prompt, enter the number of the fax machine that will receive the forwarded faxes.
 5. At the prompt, enter a start time and date and a stop time and date.
 6. Press **OK**.

Fax Forwarding appears on the control-panel display.

If the HP Fax loses power when **Fax Forwarding** is set up, it saves the **Fax Forwarding** setting and phone number. When power is restored to the HP Fax, the **Fax Forwarding** setting is still **On**.



NOTE: You can cancel fax forwarding by pressing **Cancel** on the control panel when the **Fax Forwarding** message is visible on the display, or you can select **Off** from the **Fax Forwarding Black Only** menu.

Set the paper size for received faxes

You can select the paper size for received faxes. The paper size you select should match what is loaded in your input tray. Faxes can be printed on letter, A4, or legal paper only.

 **NOTE:** If an incorrect paper size is loaded in the input tray when you receive a fax, the fax does not print and an error message appears on the display. Load letter, A4, or legal paper, and then press **OK** to print the fax.

To set the paper size for received faxes from the control panel

1. Press **Setup**.
2. Select **Basic Fax Setup** and then select **Fax Paper Size**.
3. Press ► to select an option, and then press **OK**.

Set automatic reduction for incoming faxes

The **Automatic Reduction** setting determines what the HP Fax does if it receives a fax that is too large for the default paper size. This setting is turned on by default, so the image of the incoming fax is reduced to fit on one page, if possible. If this feature is turned off, information that does not fit on the first page is printed on a second page. **Automatic Reduction** is useful when you receive a legal-size fax and letter-size paper is loaded in the input tray.

To set automatic reduction from the control panel

1. Press **Setup**.
2. Select **Advanced Fax Setup** and then select **Automatic Reduction**.
3. Press ► to select **Off** or **On**.
4. Press **OK**.

Block junk fax numbers

If you subscribe to a caller ID service through your phone provider, you can block specific fax numbers so the HP Fax does not print faxes received from those numbers. When an incoming fax call is received, the HP Fax compares the number to the list of junk fax numbers to determine if the call should be blocked. If the number matches a number in the blocked fax numbers list, the fax is not printed. (The maximum number of fax numbers you can block varies by model.)

 **NOTE:** This feature is not supported in all countries/regions. If it is not supported in your country/region, **Junk Fax Blocker Set Up** does not appear in the **Basic Fax Setup** menu.

NOTE: If no phone numbers are added in the Caller ID list, it is assumed that the user has not signed up for the Caller ID service with the phone company.

Set the junk fax mode

By default, **Block Junk Fax** mode is turned **On**. If you do not subscribe to a caller ID service through your phone provider, or do not want to use this feature, you can turn off this setting.

Add numbers to the junk fax list

There are two ways to add a number to your junk list. You can select numbers from your caller ID history, or you can enter new numbers. The numbers in your junk list are blocked if **Block Junk Fax** mode is set to **On**.

To select a number from the caller ID list

1. Press **Setup**.
2. Press **Basic Fax Setup**, and then press **Junk Fax Blocker Setup**.
3. Press **Add number to Junk List**, and then press **Select Number**.
4. Press ► to scroll through the numbers from which you have received faxes. When the number you want to block appears, press **OK** to select it.
5. When the **Select Another?** prompt appears, do one of the following:
 - **If you want to add another number to the list of junk fax numbers**, press **Yes**, and then repeat step 4 for each number you want to block.
 - **If you are done**, press **No**.

To manually enter a number to block

1. Press **Setup**.
2. Press **Basic Fax Setup**, and then press **Junk Fax Blocker Setup**.
3. Press **Add number to Junk List**, and then press **Enter Number**.
4. Use the keypad to enter a fax number to block, and then press **OK**.
Make sure you enter the fax number as it appears on the control-panel display, and not the fax number that appears on the fax header of the received fax, as these numbers can be different.
5. When the **Enter Another?** prompt appears, do one of the following:
 - **If you want to add another number to the list of junk fax numbers**, press **Yes**, and then repeat step 4 for each number you want to block.
 - **If you are done**, press **No**.

Remove numbers from the junk fax list

If you no longer want to block a fax number, you can remove a number from your junk fax list.

To remove numbers from the list of junk fax numbers

1. Press **Setup**.
2. Press **Basic Fax Setup**, and then press **Junk Fax Blocker Setup**.
3. Press **Remove Number from Junk List**.
4. Press ► to scroll through the numbers you have blocked. When the number you want to remove appears, press **OK** to select it.
5. When the **Delete Another?** prompt appears, do one of the following:
 - **If you want to remove another number from the list of junk fax numbers**, press **Yes**, and then repeat step 4 for each number you want to block.
 - **If you are done**, press **No**.

Change fax settings

After completing the steps in the setup poster that came with the HP Fax, use the following steps to change the initial settings or to configure other options for faxing.

- [Configure the fax header](#)
- [Set the number of rings before answering](#)
- [Change the answer ring pattern for distinctive ring](#)
- [Set the fax error correction mode](#)
- [Set the dial type](#)
- [Set the redial options](#)
- [Set the fax speed](#)

Configure the fax header

The fax header prints your name and fax number on the top of every fax you send. You can set up the fax header from the control panel, as described here.

 **NOTE:** In some countries/regions, the fax header information is a legal requirement.

To set or change the fax header

1. Press **Setup**.
2. Press **Basic Fax Setup**, and then press **Fax Header**.
3. Enter your personal or company name using the numeric keypad, and then press **OK**.
4. Enter your fax number by using the numeric keypad, and then press **OK**.

Set the number of rings before answering

You can specify how many rings occur before incoming calls are automatically answered.

The **Rings to Answer** setting is important if you have an answering machine on the same phone line as the HP Fax, because you want the answering machine to answer the phone before the HP Fax does. The number of rings to answer for the HP Fax should be greater than the number of rings to answer for the answering machine.

For example, set your answering machine to a low number of rings and the HP Fax to answer in the maximum number of rings. (The maximum number of rings varies by country/region.) In this setup, the answering machine answers the call and the HP Fax monitors the line. If the HP Fax detects fax tones, it receives the fax. If the call is a voice call, the answering machine records the incoming message.

To set the number of rings before answering via the control panel

1. Press **Setup**.
2. Press **Basic Fax Setup**, and then press **Rings to Answer**.
3. Enter the appropriate number of rings by using the keypad, or press ◀ or ▶ to change the number of rings.
4. Press **OK** to accept the setting.

Change the answer ring pattern for distinctive ring

Many phone companies offer a distinctive ring feature that allows you to have several phone numbers on one phone line. When you subscribe to this service, each number is assigned a different ring pattern. You can set up the HP Fax to answer incoming calls that have a specific ring pattern.

If you connect the HP Fax to a line with distinctive ring, have your telephone company assign one ring pattern to voice calls and another ring pattern to fax calls. HP recommends that you request double or triple rings for a fax number. When the HP Fax detects the specified ring pattern, it answers the call and receives the fax.

If you do not have a distinctive ring service, use the default ring pattern, which is **All Rings**.

 **NOTE:** The HP Fax cannot receive faxes when the main phone number is off the hook.

To change the answer ring pattern for distinctive ring via the control panel

1. Verify that the HP Fax is set to answer fax calls automatically.
2. Press **Setup**.
3. Press **Advanced Fax Setup**, and then press **Distinctive Ring**.
4. Press **▶** to select an option, and then press **OK**.

When the phone rings with the ring pattern assigned to your fax line, the HP Fax answers the call and receives the fax.

Set the fax error correction mode

Typically, the HP Fax monitors the signals on the phone line while it is sending or receiving a fax. If it detects an error signal during the transmission and the error-correction setting is on, the HP Fax can request that a portion of the fax be resent.

Turn off error correction only if you are having trouble sending or receiving a fax, and you want to accept the errors in the transmission. Turning off the setting might be useful when you are trying to send a fax to another country/region or receive a fax from another country/region, or if you are using a satellite phone connection.

To set the fax error-correction mode

- ▲ **Control panel:** Press **Fax Menu**, open the **Advanced Fax Setup** menu, and then use the **Error correction mode** option.

Set the dial type

Use this procedure to set tone-dialing or pulse-dialing mode. The factory-set default is **Tone**. Do not change the setting unless you know that your phone line cannot use tone dialing.

 **NOTE:** The pulse-dialing option is not available in all countries/regions.

To set the dial type

- ▲ **Control panel:** Press **Setup**, press **Basic Fax Setup**, and then use the **Tone or Pulse Dialing** option.

Set the redial options

If the HP Fax was unable to send a fax because the receiving fax machine did not answer or was busy, the HP Fax attempts to redial based on the settings for the busy-redial and no-answer-redial options. Use the following procedure to turn the options on or off.

- **Busy redial:** If this option is turned on, the HP Fax redials automatically if it receives a busy signal. The factory-set default for this option is **ON**.
- **No answer redial:** If this option is turned on, the HP Fax redials automatically if the receiving fax machine does not answer. The factory-set default for this option is **OFF**.

To set the redial options

- ▲ **Control panel:** Press **Setup**, press **Advanced Fax Setup**, and then use the **Busy Redial** or **No Answer Redial** options.

Set the fax speed

You can set the fax speed used to communicate between your HP Fax and other fax machines when sending and receiving faxes. The default fax speed is **Fast**.

If you use one of the following, setting the fax speed to a slower speed might be required:

- An Internet phone service
- A PBX system
- Fax over Internet Protocol (FoIP)
- An integrated services digital network (ISDN) service

If you experience problems sending and receiving faxes, you might want to try setting the **Fax Speed** setting to **Medium** or **Slow**. The following table provides the available fax speed settings.

| Fax speed setting | Fax speed |
|-------------------|-------------------|
| Fast | v.34 (33600 baud) |
| Medium | v.17 (14400 baud) |
| Slow | v.29 (9600 baud) |

To set the fax speed from the control panel

1. Press **Setup**.
2. Select **Advanced Fax Setup**, and then press **Fax Speed**.
3. Select an option using the arrow keys, and then press **OK**.

Fax over the Internet

You may subscribe to a low cost phone service that allows you to send and receive faxes with your HP Fax by using the Internet. This method is called Fax over Internet Protocol (FoIP). You probably use a FoIP service (provided by your telephone company) if you:

- Dial a special access code along with the fax number, or
- Have an IP converter box that connects to the Internet and provides analog phone ports for the fax connection.



NOTE: You can only send and receive faxes by connecting a phone cord to the port labeled "1-LINE" on the HP Fax. This means that your connection to the Internet must be done either through a converter box (which supplies regular analog phone jacks for fax connections) or your telephone company.

Some Internet faxing services do not work properly when the HP Fax is sending and receiving faxes at high speed (v.34, 33600bps). If you experience problems sending and receiving faxes while using an Internet fax service, use a slower fax speed. You can do this by changing the **Fax Speed** setting from **High** (the default) to **Medium**. For information on changing this setting, see [Set the fax speed](#).

If you have questions about internet faxing, contact your internet faxing services support department.

Cancel a fax

You can cancel a fax you are sending or receiving at any time.

To cancel a fax

- ▲ Press **Cancel** on the control panel to stop a fax you are sending or receiving. If the HP Fax does not stop faxing, press **Cancel** again.
The HP Fax prints any pages it has already started printing and then cancels the remainder of the fax. This can take a few moments.

To cancel a number you are dialing

- ▲ Press **Cancel** to cancel a number you are currently dialing.

4 Copy

You can make quality copies using the HP Fax.

- [Make copies from the control panel](#)
- [Change the copy settings](#)
- [Set the number of copies](#)
- [Set the copy paper size](#)
- [Set the copy paper type](#)
- [Change copy speed or quality](#)
- [Resize an original to fit onto letter or A4 paper](#)
- [Copy a legal-size document onto letter paper](#)
- [Adjust the lightness and darkness of your copy](#)
- [Enhance blurred areas of your copy](#)
- [Enhance light areas of your copy](#)
- [Cancel a copy job](#)

Make copies from the control panel

Use the following instructions to make copies on the HP Fax.

To make a copy from the control panel

1. Make sure you have paper loaded in the input tray.
2. Load your original using the ADF. For more information, see [Load originals](#).
3. Do one of the following:
 - Press **START COPY Black** to start a black-and-white copy job.
 - Press **START COPY Color** to start a color copy job.



NOTE: If you have a color original, pressing **START COPY Black** produces a black-and-white copy of the color original, while pressing **START COPY Color** produces a full-color copy of the color original.

Change the copy settings

You can customize the copy settings to handle nearly any task.

When you change copy settings, the changes are for the current copy job only. You must set the changes as defaults for the settings to apply to all future copy jobs.

To save the current settings as defaults for future jobs

1. Make any necessary changes to the settings in the **Copy Menu**.
2. Press **Copy Menu**, and then press the arrow keys until **Set New Defaults** appears.
3. Press the arrow keys to select **Yes**, and then press **OK**.

Set the number of copies

You can set the number of copies that you want to print by using the **Number of Copies** option.

To set the number of copies from the control panel

1. Make sure you have paper loaded in the input tray.
2. Load your original print side down in the document feeder tray.
Place the pages so that the top edge of the document goes in first.
3. In the Copy area, press **Copy Menu** repeatedly until **Number of Copies** appears.
4. Press **▶** or use the keypad to enter the number of copies, up to the maximum.
(The maximum number of copies varies by model.)

 **TIP:** If you hold down either of the arrow buttons, the number of copies changes by increments of 5 to make it easier to set a large number of copies.

5. Press **START COPY Black** or **START COPY Color**.

Set the copy paper size

You can set the paper size on the HP Fax. The paper size you select should match what is loaded in your input tray.

To set the paper size from the control panel

1. In the Copy area, press **Copy Menu** repeatedly until **Copy Paper Size** appears.
2. Press **▶** until the appropriate paper size appears.
3. Press **START COPY Black** or **START COPY Color**.

Set the copy paper type

You can set the paper type on the HP Fax.

To set the paper type for copies from the control panel

1. In the Copy area, press **Copy Menu** repeatedly until **Paper Type** appears.
2. Press **▶** until the appropriate paper type appears.
3. Press **START COPY Black** or **START COPY Color**.

Refer to the following table to determine which paper type setting to choose based on the paper loaded in the input tray.

| Paper type | Control panel setting |
|-------------------------------------|-----------------------|
| Copier paper or letterhead | Plain Paper |
| HP Bright White Paper | Plain Paper |
| HP Premium Plus Photo Paper, Glossy | Premium Photo |
| HP Premium Plus Photo Paper, Matte | Premium Photo |

(continued)

| Paper type | Control panel setting |
|---|-----------------------|
| HP Premium or Premium Plus Inkjet Transparency Film | Transparency |
| Other transparency film | Transparency |

Change copy speed or quality

The HP Fax provides three options that affect copy speed and quality:

- **Best** produces the highest quality for all paper and eliminates the banding (striping) effect that sometimes occurs in solid areas. **Best** copies slower than the other quality settings.
- **Normal** delivers high-quality output and is the recommended setting for most of your copying. **Normal** copies faster than **Best** and is the default setting.
- **Fast** copies faster than the **Normal** setting. The text is comparable to the quality of the **Normal** setting, but the graphics might be lower quality. The **Fast** setting uses less ink and extends the life of your print cartridges.

To change the copy quality from the control panel

1. Make sure you have paper loaded in the input tray.
2. Load your original print side down in the document feeder tray.
Place the pages so that the top edge of the document goes in first.
3. In the Copy area, press **Quality** until the appropriate quality setting is lit.
4. Press **START COPY Black** or **START COPY Color**.

Resize an original to fit onto letter or A4 paper

If the image or text on your original fills the entire sheet with no margins, use **Fit to Page** or **Full Page 91%** to reduce your original and prevent unwanted cropping of the text or images at the edges of the sheet.



To resize a document from the control panel

1. Make sure you have paper loaded in the input tray.
2. Load your original print side down in the document feeder tray.
Place the pages so that the top edge of the document goes in first.
3. In the Copy area, press **Copy Menu** repeatedly until **Reduce / Enlarge** appears.
4. Press **▶** until **Full Page 91%** appears.
5. Press **START COPY Black** or **START COPY Color**.

Copy a legal-size document onto letter paper

You can use the **Legal > Ltr 72%** setting to reduce a copy of a legal-size document to a size that fits onto letter paper.

 **NOTE:** The percentage in the example, **Legal > Ltr 72%**, might not match the percentage that appears in the display.

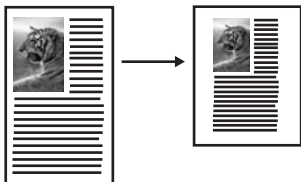

To copy a legal-size document onto letter paper from the control panel

1. Make sure you have paper loaded in the input tray.
2. Load your legal-size document print side down in the document feeder tray.
Place the page in the document feeder tray so that the top edge of the document goes in first.
3. In the Copy area, press **Copy Menu** repeatedly until **Reduce / Enlarge** appears.
4. Press **▶** until **Legal > Ltr 72%** appears.
5. Press **START COPY Black** or **START COPY Color**.

Adjust the lightness and darkness of your copy

You can use the **Lighter / Darker** option to adjust the contrast of the copies you make.

To adjust the copy contrast from the control panel

1. Make sure you have paper loaded in the input tray.
2. Load your original print side down in the document feeder tray.
Place the pages so that the top edge of the document goes in first.
3. In the Copy area, press **Copy Menu** repeatedly until **Lighter / Darker** appears.
4. Do one of the following:
 - Press **▶** to darken the copy.
 - Press **◀** to lighten the copy.
5. Press **START COPY Black** or **START COPY Color**.

Enhance blurred areas of your copy

You can use the **Enhancements** feature to adjust the quality of text documents by sharpening edges of black text or adjust images/embedded pictures by enhancing light colors that might otherwise appear white.

The **Mixed** enhancement is the default option. Use the **Mixed** enhancement to sharpen edges of most originals.

To copy a blurred document from the control panel

1. Make sure you have paper loaded in the input tray.
2. Load your original print side down in the document feeder tray.
3. In the Copy area, press **Copy Menu** repeatedly until **Enhancements** appears.
4. Press ► until the **Text** setting appears.
5. Press **START COPY Black** or **START COPY Color**.

If any of the following occur, turn off **Text** enhancement by selecting **Photo** or **None**:

- Stray dots of color surround some text on your copies
- Large, black typefaces look splotchy (not smooth)
- Thin, colored objects or lines contain black sections
- Horizontal grainy or white bands appear in light- to medium-gray areas

Enhance light areas of your copy

You can use **Photo** enhancements to enhance light colors that might otherwise appear white. You can also use **Photo** enhancements to eliminate or reduce any of the following that might occur when copying with **Text** enhancements:

- Stray dots of color surround some text on your copies
- Large, black typefaces look splotchy (not smooth)
- Thin, colored objects or lines contain black sections
- Horizontal grainy or white bands appear in light- to medium-gray areas

To copy an overexposed image/embedded picture from the control panel

1. Make sure you have paper loaded in the input tray.
2. Load your original print side down in the document feeder tray.
3. In the Copy area, press **Copy Menu** repeatedly until **Enhancements** appears.
4. Press ► until the **Photo** enhancement setting appears.
5. Press **START COPY Color**.

Cancel a copy job

- ▲ To stop copying, press **Cancel** on the control panel.

5 Configure and manage

This section is intended for the administrator or individual who is responsible for managing the HP Fax. Use the control panel to manage and monitor the HP Fax.

- [Manage the HP Fax](#)
- [Use reports](#)
- [Test fax setup](#)
- [The fax test failed](#)

Manage the HP Fax

Use the control panel to modify the following settings:

| | |
|-----------------------------|---|
| Language and country/region | Press Setup , and then open the Preferences menu. If you do not see your country/region, press 99, and then find your country/region in the list. |
| Fax sound volume | Press Setup , and then open the Basic Fax Setup menu. |
| Automatic report printing | Press Reports , and then open the appropriate menu. |
| Set the dial type | Press Setup , and then open the Basic Fax Setup menu. |
| Set up redial options | Press Setup , and then open the Advanced Fax Setup menu. |
| Set the date and time | Press Setup , press Tools , and then press Date and Time . |

Use reports

You can set up the HP Fax to print error reports and confirmation reports automatically for each fax you send and receive. You can also manually print system reports as required; these reports provide useful system information about the HP Fax.

By default, the HP Fax is set to print a report only if there is a problem sending or receiving a fax. A confirmation message that indicates whether a fax was successfully sent appears briefly on the control-panel display after each transaction.

- [Print fax confirmation reports](#)
- [Print fax error reports](#)
- [Print and view the fax log](#)

Print fax confirmation reports

If you require printed confirmation that your faxes were successfully sent, follow these instructions to enable fax confirmation **before** sending any faxes. Select either **On Fax Send** or **Send & Receive**.

The default fax confirmation setting is **Off**. This means that a confirmation report is not printed for each fax sent or received. A confirmation message indicating whether a fax was successfully sent appears briefly on the control-panel display after each transaction.

To enable fax confirmation

1. Press **Reports**.
2. Press **Fax Confirmation**.
3. Press ► to select one of the following, and then press **OK**.

| | |
|---------------------------|---|
| Off | Does not print a fax confirmation report when you send and receive faxes successfully. This is the default setting. |
| On Fax Send | Prints a fax confirmation report for every fax you send. |
| On Fax Receive | Prints a fax confirmation report for every fax you receive. |
| Send & Receive | Prints a fax confirmation report for every fax you send and receive. |

 **TIP:** If you choose **On Fax Send** or **Send & Receive**, and scan your fax to send from memory, you can include an image of the first page of the fax on the **Fax Sent Confirmation** report. Press **Setup**, press **Fax Confirmation**, and then press **On Fax Send** again. Select **On** from the **Image on Fax Send Report** menu.

Print fax error reports

You can configure the HP Fax so that it automatically prints a report when there is an error during transmission or reception.

To set the HP Fax to print fax error reports automatically

1. Press **Reports**.
2. Press **Fax Error Report**.
3. Press ► to select one of the following, and then press **OK**.

| | |
|---------------------------|--|
| Send & Receive | Prints whenever a fax error occurs. This is the default setting. |
| Off | Does not print any fax error reports. |
| On Fax Send | Prints whenever a transmission error occurs. |
| On Fax Receive | Prints whenever a receiving error occurs. |

Print and view the fax log

The logs list faxes that have been sent from the control panel and all faxes that have been received.

You can print a log of faxes that have been received and sent by the HP Fax. Each entry in the log contains the following information:

- Transmission date and time
- Type (whether received or sent)
- Fax number

- Duration
- Number of pages
- Result (status) of transmission

To print the fax log from the control panel

1. On the control panel, press **Reports**.
2. Press the arrow key to move down to **Fax Log**, and then press **OK**.

Test fax setup

You can test your fax setup to check the status of the HP Fax and to make sure it is set up properly for faxing. Perform this test after you have completed setting up the HP Fax for faxing. The test does the following:

- Tests the fax hardware
- Verifies the correct type of phone cord is connected to the HP Fax
- Checks that the phone cord is plugged into the correct port
- Checks for a dial tone
- Checks for an active phone line
- Tests the status of your phone line connection

The HP Fax prints a report with the results of the test. If the test fails, review the report for information on how to fix the problem and rerun the test.

To test fax setup

1. Set up the HP Fax for faxing according to your particular home or office setup instructions.
2. Make sure the print cartridges are installed, and that full-size paper is loaded in the input tray before starting the test.
3. From the control panel, press **Setup**.
4. Select **Tools**, and then select **Run Fax Test**.
The HP Fax displays the status of the test on the display and prints a report.
5. Review the report.
 - If the test passes and you are still having problems faxing, check the fax settings listed in the report to verify the settings are correct. A blank or incorrect fax setting can cause problems faxing.
 - If the test fails, review the report for more information on how to fix any problems found.

The fax test failed

If you ran a fax test and the test failed, review the report for basic information about the error and to see which part of the test failed. To resolve the error, locate the topic that best matches the test failure and try the solutions.

After you resolve any problems found, run the fax test again to make sure it passes and the HP Fax is ready for faxing. If the **Fax Hardware Test** continues to fail and you experience problems faxing, contact HP Support. Go to www.hp.com/support. If

prompted, choose your country/region, and then click **Contact HP** for information on calling for technical support.

- [The "Fax Hardware Test" failed](#)
- [The "Fax Connected to Active Telephone Wall Jack" test failed](#)
- [The "Phone Cord Connected to Correct Port on Fax" test failed](#)
- [The "Using Correct Type of Phone Cord with Fax" test failed](#)
- [The "Dial Tone Detection" test failed](#)
- [The "Fax Line Condition" test failed](#)

The "Fax Hardware Test" failed

Solution:

- Unplug the power cord from the back of the HP Fax. After a few seconds, plug the power cord in again. Run the test again. If the test fails again, continue reviewing the troubleshooting information in this section.
 - Try to send or receive a test fax. If you can send or receive a fax successfully, there might not be a problem.
 - Make sure you use the phone cord that came with the HP Fax. If you do not use the supplied phone cord to connect from the telephone wall jack to the HP Fax, you might not be able to send or receive faxes. After you plug in the phone cord that came with the HP Fax, run the fax test again.
 - If you are using a phone splitter, this can cause faxing problems. (A splitter is a two-cord connector that plugs into a telephone wall jack.) Try removing the splitter and connecting the HP Fax directly to the telephone wall jack.
-

The "Fax Connected to Active Telephone Wall Jack" test failed

Solution:

- Check the connection between the telephone wall jack and the HP Fax to make sure the phone cord is secure.
 - Make sure you have correctly connected the HP Fax to the telephone wall jack. Using the phone cord supplied in the box with the HP Fax, connect one end to your telephone wall jack, then connect the other end to the port labeled 1-LINE on the back of the HP Fax. If you do not use the supplied phone cord to connect from the telephone wall jack to the HP fax, you might not be able to send or receive faxes. For more information on setting up the HP Fax for faxing, see the Setup Poster.
 - If you are using a phone splitter, this can cause faxing problems. (A splitter is a two-cord connector that plugs into a telephone wall jack.) Try removing the splitter and connecting the HP Fax directly to the telephone wall jack.
 - Try connecting a working phone and phone cord to the telephone wall jack that you are using for the HP Fax and check for a dial tone. If you do not hear a dial tone, contact your telephone company and have them check the line.
 - Try to send or receive a test fax. If you can send or receive a fax successfully, there might not be a problem.
-

The "Phone Cord Connected to Correct Port on Fax" test failed

Solution: Plug the phone cord into the correct port.

1. Using the phone cord supplied in the box with the HP Fax, connect one end to your telephone wall jack, then connect the other end to the port labeled 1-LINE on the back of the HP Fax.

 **NOTE:** If you use the 2-EXT port to connect to the telephone wall jack, you will not be able to send or receive faxes. The 2-EXT port should only be used to connect other equipment, such as an answering machine.

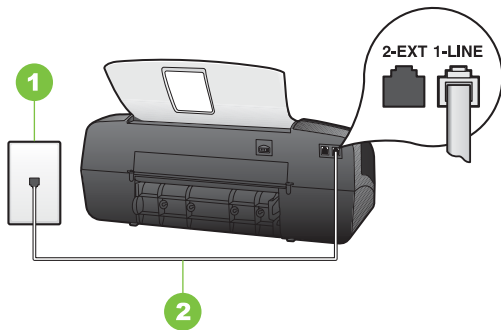

| | |
|---|--|
| 1 | Telephone wall jack |
| 2 | Use the phone cord supplied in the box with the device to connect to the "1-LINE" port |

2. After you have connected the phone cord to the port labeled 1-LINE, run the fax test again to make sure it passes and that the HP Fax is ready for faxing.
 3. Try to send or receive a test fax.
 - Make sure you use the phone cord that came with the HP Fax. If you do not use the supplied phone cord to connect from the telephone wall jack to the HP Fax, you might not be able to send or receive faxes. After you plug in the phone cord that came with the HP Fax, run the fax test again.
 - If you are using a phone splitter, this can cause faxing problems. (A splitter is a two-cord connector that plugs into a telephone wall jack.) Try removing the splitter and connecting the HP Fax directly to the telephone wall jack.
-

The "Using Correct Type of Phone Cord with Fax" test failed

Solution:

- Make sure you used the phone cord supplied in the box with the HP Fax to connect to the telephone wall jack. One end of the phone cord should be connected to the port labeled 1-LINE on the back of the HP Fax, and the other end to your telephone wall jack. If you do not use the supplied phone cord to connect from the telephone wall jack to the HP Fax, you might not be able to send or receive faxes.
If the phone cord that came with the HP Fax is not long enough, you can use a coupler to extend the length. You can purchase a coupler at an electronics store that carries phone accessories. You will also need another phone cord, which can be a standard phone cord that you might already have in your home or office.
 - Check the connection between the telephone wall jack and the HP Fax to make sure the phone cord is secure.
 - If you are using a phone splitter, this can cause faxing problems. (A splitter is a two-cord connector that plugs into a telephone wall jack.) Try removing the splitter and connecting the HP Fax directly to the telephone wall jack.
-

The "Dial Tone Detection" test failed

Solution:

- Other equipment, which uses the same phone line as the HP Fax, might be causing the test to fail. To find out if other equipment is causing a problem, disconnect the other equipment from the phone line, and then run the test again. If the **Dial Tone Detection Test** passes without the other equipment, then one or more pieces of the equipment is causing problems; try adding them back one at a time and rerunning the test each time, until you identify which piece of equipment is causing the problem.
- Try connecting a working phone and phone cord to the telephone wall jack that you are using for the HP Fax and check for a dial tone. If you do not hear a dial tone, contact your telephone company and have them check the line.
- Make sure you have correctly connected the HP Fax to the telephone wall jack. Using the phone cord supplied in the box with the HP Fax, connect one end to your telephone wall jack, then connect the other end to the port labeled 1-LINE on the back of the HP Fax. If you do not use the supplied phone cord to connect from the telephone wall jack to the HP Fax, you might not be able to send or receive faxes.
- If you are using a phone splitter, this can cause faxing problems. (A splitter is a two-cord connector that plugs into a telephone wall jack.) Try removing the splitter and connecting the HP Fax directly to the telephone wall jack.
- If your telephone system is not using a standard dial tone, such as some PBX systems, this might cause the test to fail. This will not cause a problem sending or receiving faxes. Try sending or receiving a test fax.

- Check to make sure the country/region setting is set appropriately for your country/region. If the country/region setting is not set or is set incorrectly, the test might fail and you might have problems sending and receiving faxes.
 - Make sure you connect the HP Fax to an analog phone line or you will not be able to send or receive faxes. To check if your phone line is digital, connect a regular analog phone to the line and listen for a dial tone. If you do not hear a normal sounding dial tone, it might be a phone line set up for digital phones. Connect the HP Fax to an analog phone line and try sending or receiving a fax.
-

The "Fax Line Condition" test failed

Solution:

- Make sure you connect the HP Fax to an analog phone line or you will not be able to send or receive faxes. To check if your phone line is digital, connect a regular analog phone to the line and listen for a dial tone. If you do not hear a normal sounding dial tone, it might be a phone line set up for digital phones. Connect the HP Fax to an analog phone line and try sending or receiving a fax.
 - Check the connection between the telephone wall jack and the HP Fax to make sure the phone cord is secure.
 - Make sure you have correctly connected the HP Fax to the telephone wall jack. Using the phone cord supplied in the box with the HP Fax, connect one end to your telephone wall jack, then connect the other end to the port labeled 1-LINE on the back of the HP Fax. If you do not use the supplied phone cord to connect from the telephone wall jack to the HP Fax, you might not be able to send or receive faxes.
 - Other equipment, which uses the same phone line as the HP Fax, might be causing the test to fail. To find out if other equipment is causing a problem, disconnect the other equipment from the phone line, and then run the test again.
 - If the **Fax Line Condition Test** passes without the other equipment, then one or more pieces of the equipment is causing problems; try adding them back one at a time and rerunning the test each time, until you identify which piece of equipment is causing the problem.
 - If the **Fax Line Condition Test** fails without the other equipment, connect the HP Fax to a working phone line and continue reviewing the troubleshooting information in this section.
 - If you are using a phone splitter, this can cause faxing problems. (A splitter is a two-cord connector that plugs into a telephone wall jack.) Try removing the splitter and connecting the HP Fax directly to the telephone wall jack.
-

6 Maintain and troubleshoot

- [Work with print cartridges](#)
- [Clean the HP Fax](#)
- [Troubleshooting tips and resources](#)
- [Solve printing problems](#)
- [Poor print quality and unexpected printouts](#)
- [Solve paper-feed problems](#)
- [Solve copy problems](#)
- [Solve fax problems](#)
- [Troubleshoot setup issues](#)
- [Clear paper jams](#)
- [Avoid paper jams](#)

Work with print cartridges

- [Print cartridges](#)
- [Handle the print cartridges](#)
- [Replace the print cartridges](#)
- [Align the print cartridges](#)
- [Clean the print cartridges](#)
- [Clean the print cartridge contacts](#)
- [Clean the area around the ink nozzles](#)
- [Store print cartridges](#)

Print cartridges

You can find the cartridge number on the label of the print cartridge you are replacing.

The HP Fax uses the following print cartridges:

- HP 21 black inkjet print cartridge
- HP 22 tri-color inkjet print cartridge
- HP 54 black inkjet print cartridge

 **NOTE:** Ink from the cartridges is used in the printing process in a number of different ways, including in the initialization process, which prepares the HP Fax and cartridges for printing. In addition, some residual ink is left in the cartridge after it is used. For more information see www.hp.com/go/inkusage.

NOTE: Ordering print cartridges online is not supported in all countries/regions. If it is not supported in your country/region, contact a local HP reseller for information about purchasing print cartridges.

Handle the print cartridges

Before you replace or clean a print cartridge, you should know the part names and how to handle the print cartridges.

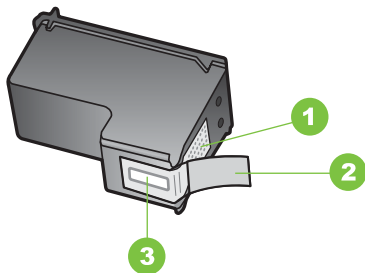

| | |
|---|---|
| 1 | Copper-colored contacts |
| 2 | Plastic tape with pink pull tab (must be removed before installing) |
| 3 | Ink nozzles under tape |

Hold the print cartridges by their black plastic sides, with the label on top. Do not touch the copper-colored contacts or the ink nozzles.



 **NOTE:** Handle the print cartridges carefully. Dropping or jarring cartridges can cause temporary printing problems, or even permanent damage.

Replace the print cartridges

Follow these instructions when the ink level is low.

 **NOTE:** When the ink level for a print cartridge is low, a message appears on the display.

When you receive a low-ink warning message on the display, make sure you have a replacement print cartridge available. You should also replace the print cartridges when you see faded text or if you experience print quality issues related to the print cartridges.

To order print cartridges for the HP Fax, go to www.hpshopping.com. If prompted, choose your country/region, follow the prompts to select your product, and then click one of the shopping links on the page.

To replace the print cartridges

1. Make sure the HP Fax is plugged in.

△ **CAUTION:** If the HP Fax is off when you open the print cartridge door to access the print cartridges, it will not release the cartridges for changing. You might damage the HP Fax if the print cartridges are not docked safely when you try to remove them.

2. Open the print cartridge door.
The print carriage moves to the far right side of the HP Fax.



3. Wait until the print carriage is idle and silent, and then lightly press down on a print cartridge to release it.
If you are replacing the tri-color print cartridge, remove the print cartridge from the slot on the left.
If you are replacing the black print cartridge, remove the print cartridge from the slot on the right.

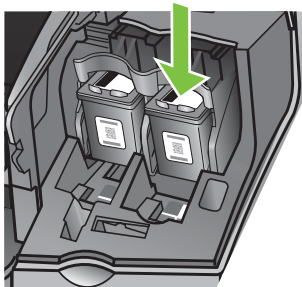

4. Pull the print cartridge toward you out of its slot.
5. If you are removing the print cartridge because it is low or out of ink, recycle the print cartridge. The HP Inkjet Supplies Recycling Program is available in many countries/regions, and lets you recycle used print cartridges free of charge. For more information, go to the following Web site:

www.hp.com/hpinfo/globalcitizenship/environment/recycle/inkjet.html

- 6. Remove the new print cartridge from its packaging and, being careful to touch only the black plastic, gently remove the plastic tape by using the pink pull tab.

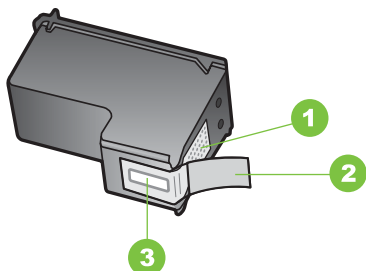

| | |
|---|---|
| 1 | Copper-colored contacts |
| 2 | Plastic tape with pink pull tab (must be removed before installing) |
| 3 | Ink nozzles under tape |

△ **CAUTION:** Do not touch the copper-colored contacts or ink nozzles. Touching these parts can result in clogs, ink failure, and bad electrical connections.



- 7. Slide the new print cartridge forward into the empty slot. Then gently push on the upper part of the print cartridge forward until it clicks into the socket. If you are installing the tri-color print cartridge, slide it into the left slot. If you are installing a black print cartridge, slide it into the right slot.

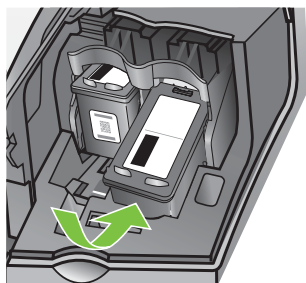

- 8. Close the print cartridge door.

Align the print cartridges

The HP Fax prompts you to align cartridges every time you install or replace a print cartridge. You can also align the print cartridges at any time from the control panel. Aligning the print cartridges ensures high-quality output.

 **NOTE:** If you remove and reinstall the same print cartridge, the HP Fax will not prompt you to align the print cartridges. It remembers the alignment values for that print cartridge, so you do not need to realign the print cartridges.

To align the print cartridges from the control panel when prompted

1. Make sure you have letter or A4 unused plain white paper loaded in the input tray, and then press **OK**. The HP Fax prints a test page.
2. Load the test page print side down in the ADF, and press **OK**. Recycle or discard the page after the alignment is completed.

 **NOTE:** If you have colored paper loaded in the input tray when you align the print cartridges, the alignment will fail. Load unused plain white paper into the input tray, and then try the alignment again.

If the alignment fails again, you might have a defective sensor or print cartridge. Contact HP Support. Go to www.hp.com/support. If prompted, choose your country/region, and then click **Contact HP** for information on calling for technical support.

To align the cartridges from the control panel at any time

1. Load letter, A4, or legal unused plain white paper into the input tray.
2. Press **Setup**.
3. Select **Tools** and then select **Align Print Cartridge**. The HP Fax prints a test page.
4. Load the test page print side down in the ADF, and press **OK**. Recycle or discard the page after the alignment is completed.

Clean the print cartridges

Use this feature when there is streaking, white lines through any of the lines of color or when a color is muddy after installing a print cartridge for the first time.

 **NOTE:** Ink from the cartridges is used in the printing process in a number of different ways, including in the initialization process, which prepares the HP Fax and cartridges for printing. In addition, some residual ink is left in the cartridge after it is used. For more information see www.hp.com/go/inkusage.

To clean the print cartridges from the control panel

1. Load letter, A4, or legal unused plain white paper into the input tray.
2. Press **Setup**.
3. Select **Tools** and then select **Clean Print Cartridge**.

The HP Fax prints a page that you can recycle or discard.

If copy or print quality still seems poor after you clean the print cartridges, try cleaning the print cartridge contacts before replacing the affected print cartridge.

Clean the print cartridge contacts

Clean the print cartridge contacts only if you get repeated messages on the display prompting you to check a print cartridge after you already have cleaned or aligned the print cartridges.

Before cleaning the print cartridge contacts, remove the print cartridge and verify that nothing is covering the print cartridge contacts, then reinstall the print cartridge. If you continue to get messages to check the print cartridges, clean the print cartridge contacts.

Make sure you have the following materials available:

- Dry foam rubber swabs, lint-free cloth, or any soft material that will not come apart or leave fibers.



TIP: Coffee filters are lint-free and work well for cleaning print cartridges.

- Distilled, filtered, or bottled water (tap water might contain contaminants that can damage the print cartridges).



CAUTION: Do **not** use platen cleaners or alcohol to clean the print cartridge contacts. These can damage the print cartridge or the HP Fax.

To clean the print cartridge contacts

1. Plug in the HP Fax and open the print cartridge door.
The print carriage moves to the far right side of the HP Fax.
2. Wait until the print carriage is idle and silent, and then unplug the power cord from the back of the HP Fax.



NOTE: Depending how long the HP Fax is unplugged, the date and time might be erased. You might need to reset the date and time later, when you plug the power cord back in.

3. Lightly press down on the print cartridge to release it, and then pull it toward you out of the slot.



NOTE: Do not remove both print cartridges at the same time. Remove and clean each print cartridge one at a time. Do not leave a print cartridge outside the HP Fax for more than 30 minutes.

4. Inspect the print cartridge contacts for ink and debris buildup.
5. Dip a clean foam rubber swab or lint-free cloth into distilled water, and squeeze any excess water from it.
6. Hold the print cartridge by its sides.

7. Clean only the copper-colored contacts. Allow the print cartridges to dry for approximately ten minutes.

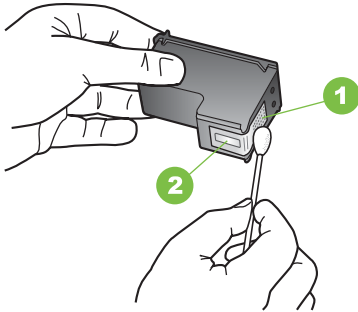

| | |
|---|----------------------------|
| 1 | Copper-colored contacts |
| 2 | Ink nozzles (do not clean) |

8. Slide the print cartridge back into the slot. Push the print cartridge forward until it clicks into place.
9. Repeat if necessary for the other print cartridge.
10. Gently close the print cartridge door and plug the power cord into the back of the HP Fax.

Clean the area around the ink nozzles

If the HP Fax is used in a dusty environment, a small amount of debris might accumulate inside the HP Fax. This debris can include dust, hair, carpet, or clothing fibers. When debris gets on the print cartridges, it can cause ink streaks and smudges on printed pages. Ink streaking can be corrected by cleaning around the ink nozzles as described here.

 **NOTE:** Clean the area around the ink nozzles only if you continue to see streaks and smudges on your printed pages after you have already cleaned the print cartridges by using the control panel.

Make sure you have the following materials available:

- Dry foam rubber swabs, lint-free cloth, or any soft material that will not come apart or leave fibers.

 **TIP:** Coffee filters are lint-free and work well for cleaning print cartridges.

- Distilled, filtered, or bottled water (tap water might contain contaminants that can damage the print cartridges).

 **CAUTION:** Do not touch the copper-colored contacts or ink nozzles. Touching these parts can result in clogs, ink failure, and bad electrical connections.

To clean the area around the ink nozzles

1. Plug in the HP Fax and open the print cartridge door.
The print carriage moves to the far right side of the HP Fax.
2. Wait until the print carriage is idle and silent, and then unplug the power cord from the back of the HP Fax.

 **NOTE:** Depending how long the HP Fax is unplugged, the date and time might be erased. You might need to reset the date and time later, when you plug the power cord back in.

3. Lightly press down on the print cartridge to release it, and then pull it toward you out of the slot.

 **NOTE:** Do not remove both print cartridges at the same time. Remove and clean each print cartridge one at a time. Do not leave a print cartridge outside the HP Fax for more than 30 minutes.

4. Place the print cartridge on a piece of paper with the ink nozzles facing up.
5. Lightly moisten a clean foam rubber swab with distilled water.
6. Clean the face and edges around the ink nozzle area with the swab, as shown below.

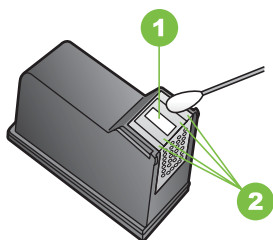

| | |
|---|---|
| 1 | Nozzle plate (do not clean) |
| 2 | Face and edges around the ink nozzle area |

 **CAUTION:** Do **not** clean the nozzle plate.

7. Slide the print cartridge back into the slot. Push the print cartridge forward until it clicks into place.
8. Repeat if necessary for the other print cartridge.
9. Gently close the print cartridge door and plug the power cord into the back of the HP Fax.

Store print cartridges

Print cartridges can be left in the device for extended periods of time. If you remove the print cartridges, place them in an airtight container, such as a resealable plastic tub. Make sure the nozzles are not touching anything when you store the print cartridges.

Clean the HP Fax

To ensure that your copies and scans remain clear, you might need to clean the glass strip or white strip inside the automatic document feeder. You might also want to dust the exterior of the HP Fax.

Clean the glass strip

Minor debris can accumulate on the white strip located inside the automatic document feeder.

To clean the glass strip inside the automatic document feeder

1. Unplug the power cord.

 **NOTE:** Depending how long the HP Fax is unplugged, the date and time might be erased. You might need to reset the date and time later, when you plug the power cord back in.

2. Lift the cover of the automatic document feeder.

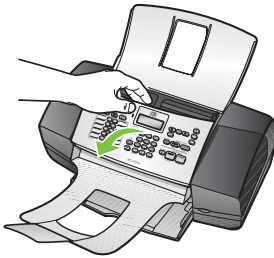

There is a glass strip under the automatic document feeder.

3. Clean the glass strip with a soft cloth or sponge slightly moistened with a nonabrasive glass cleaner.

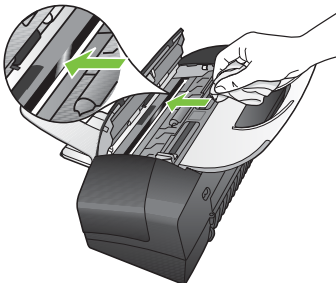

 **CAUTION:** Do not use abrasives, acetone, benzene, or carbon tetrachloride on the glass, since they can damage it. Do not place or spray liquid directly on the glass. The liquid might seep under the glass and damage the HP Fax.

4. Close the automatic document feeder cover.

△ **CAUTION:** Make sure you close the automatic document feeder cover before loading any paper or originals. If you do not close the cover, you might damage the mechanism.

5. Plug in the power cord.

Clean the white strip

Minor debris can accumulate on the white strip located inside the automatic document feeder.

To clean the white strip

1. Unplug the power cord.

📝 **NOTE:** Depending how long the HP Fax is unplugged, the date and time might be erased. You might need to reset the date and time later, when you plug the power cord back in.

2. Lift the cover of the automatic document feeder.

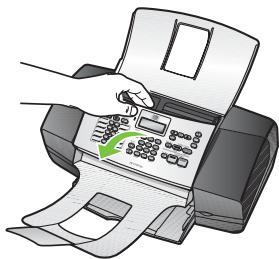

3. Clean the white strip with a soft cloth or sponge slightly moistened with a mild soap and warm water.

Wash the strip gently to loosen debris. Do not scrub the strip.

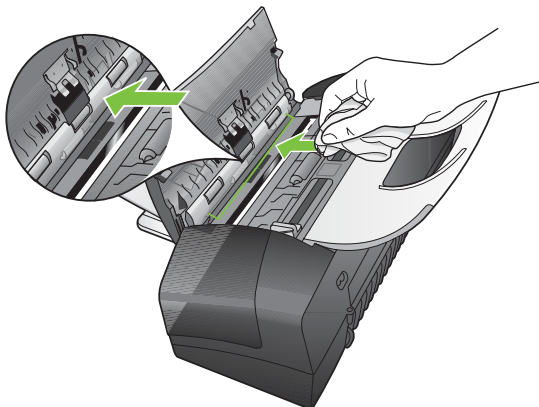

4. If further cleaning is needed, repeat the previous steps using isopropyl (rubbing) alcohol, and wipe the strip thoroughly with a damp cloth to remove any residual alcohol.

△ **CAUTION:** Be careful not to spill alcohol on the glass or exterior of the HP Fax, as this might damage the HP Fax.

5. Close the automatic document feeder cover.
6. Plug in the power cord.

Clean the exterior

 **NOTE:** Before cleaning the HP Fax, unplug the power cord from the electrical socket.

Use a soft, damp, lint-free cloth to wipe dust, smudges, and stains off of the case. The exterior of the HP Fax does not require cleaning. Keep fluids away from the interior of the HP Fax, as well as from the control panel.

Troubleshooting tips and resources

Use the following tips and resources to resolve printing problems.

- For a paper jam, see [Clear paper jams](#).
- For paper-feed problems, such as the paper skew and paper pick, see [Solve paper-feed problems](#).
- When the HP Fax is plugged in for the first time, it takes approximately 1 - 2 minutes to initialize it after the print cartridges are installed.
- Make sure the power cord and other cables are working, and are firmly connected to the HP Fax. Make sure the HP Fax is connected firmly to a functioning alternating current (AC) power outlet. For voltage requirements, see [Electrical specifications](#).
- Make sure media is loaded correctly in the input tray and is not jammed in the HP Fax.
- Make sure all packing tapes and materials are removed.

Solve printing problems

| Problem | Possible solution | More information |
|--|---------------------------------------|--|
| The HP Fax shuts down unexpectedly | Check the power and power connections | Make sure the HP Fax is connected firmly to a functioning alternating current (AC) power outlet. For voltage requirements, see Electrical specifications . |
| Error message appears on control-panel display | A non-recoverable error has occurred | Unplug the power cord, wait about 20 seconds, and plug the power cord back in. If the problem persists, visit the HP Web site (www.hp.com/support) for the latest troubleshooting information, or product fixes and updates. |
| Blank or partial page printed | Clean the print cartridge | Complete the print cartridge cleaning procedure. For more information, see Work with print cartridges . |

(continued)

| Problem | Possible solution | More information |
|---------|------------------------------------|---|
| | Check the media settings | Make sure you select the correct quality settings for the media loaded in the tray. Make sure the page settings match the page size of media loaded in the tray. |
| | More than one page is being picked | For more information on paper-feed problems, see Solve paper-feed problems . |
| | Check the print cartridges | Make sure the print cartridges are not low on ink. For more information, see Work with print cartridges . |

Poor print quality and unexpected printouts

| Problem | Possible solution | More information |
|---|---|--|
| Poor quality printouts | Check the print cartridges | Make sure the correct print cartridges are installed and the print cartridges are not low on ink. For more information, see Configure and manage and Print cartridges . |
| | Check the media | The media might not meet Hewlett-Packard media specifications (for example, the media is too moist or too rough). See Select print media for more information. |
| | Check the type of media loaded in the HP Fax | Make sure the HP Fax supports the type of media you have loaded. For more information, see Understand specifications for supported media . |
| | Align the print cartridges | Align the print cartridges. For more information, see Align the print cartridges . |
| Printout shows bleeding colors | Check the print cartridges | Make sure print cartridges have not been tampered with. Refilling processes and the use of incompatible inks can disrupt the intricate printing system and result in reduced print quality and damage to the HP Fax. HP does not guarantee or support refilled print cartridges. For ordering information, see Print cartridges and HP supplies and fax specifications . |
| | Check the type of media loaded in the HP Fax. | For more information, see Select print media . |
| Lines or dots are missing from text or graphics | Check the print cartridges | Make sure the print cartridges are not low on ink. For more information, see Work with print cartridges . |
| | Clean the print cartridges | For more information, see Work with print cartridges . |

Solve paper-feed problems

| Problem | Possible solution |
|---------------------------------------|--|
| Media is not supported for the HP Fax | Use only media that is supported for the HP Fax. For more information, see Understand specifications for supported media . |
| Media is not picked up from the tray | <ul style="list-style-type: none"> • Make sure media is loaded in the tray. For more information, see Load full-size paper. Fan the media before loading. • Make sure the paper guides are set to the correct markings in the tray for the media size you are loading. Also make sure the guides are snug, but not tight, against the stack. • Make sure media in the tray is not curled. Uncurl paper by bending it in the opposite direction of the curl. |
| Media is not coming out correctly | <ul style="list-style-type: none"> • Make sure the output tray extension is extended; otherwise, printed pages may fall off the HP Fax. • Remove excess media from the output tray. There is a limit to the number of sheets the tray can hold. |
| Pages are skewing | <ul style="list-style-type: none"> • Make sure the media loaded in the tray is aligned to the paper guides. If needed, pull out the tray from the HP Fax and reload the media properly, making sure that the paper guides are properly aligned. • Load media into the HP Fax only when it is not printing. |
| Multiple pages are being picked up | <ul style="list-style-type: none"> • Fan the media before loading. • Make sure the paper guides are set to the correct markings in the tray for the media size you are loading. Also make sure the guides are snug, but not tight, against the stack. • Make sure the tray is not overloaded with paper. • Use HP media for optimum performance and efficiency. |

Solve copy problems

| Problem | Possible solution | More information |
|------------------|--------------------------------|--|
| No copy came out | Check the power | Make sure that the power cord is securely connected. |
| | Check the status of the device | The device might be jammed. Check for jams. See Clear paper jams . |
| | Check the trays | Make sure that media is loaded. See Load full-size paper for more information. |
| Copies are blank | Check the trays | If you are copying from the ADF, make sure that the originals have been loaded correctly. For more information, see Load originals . |

(continued)

| Problem | Possible solution | More information |
|--------------------------------|---|--|
| | Check the media | The media might not meet Hewlett-Packard media specifications (for example, the media is too moist or too rough). See Select print media for more information. |
| | Check the settings | The contrast setting might be set too light. Use the Copy button on the control panel to create darker copies. |
| | Clean the print cartridges | For more information, see Work with print cartridges . |
| Documents are missing or faded | Check the media | The media might not meet Hewlett-Packard media specifications (for example, the media is too moist or too rough). See Select print media for more information. |
| | Check the settings | The quality setting of Fast (which produces draft-quality copies) might be responsible for the missing or faded documents. Change to the Normal or Best setting. |
| | Check the original | <ul style="list-style-type: none"> The accuracy of the copy depends on the quality and size of the original. Use the Copy menu to adjust the brightness of the copy. If the original is too light, the copy might not be able to compensate, even if you adjust the contrast. Colored backgrounds might cause images in the foreground to blend into the background, or the background might appear in a different shade. |
| | Clean the print cartridges | For more information, see Work with print cartridges . |
| Size is reduced | The Reduce/Enlarge or other copy feature might have been set from the control panel to reduce the scanned image. Check the settings for the copy job to make sure that they are for normal size. | |
| Copy quality is poor | Take steps to improve the copy quality | <ul style="list-style-type: none"> Use quality originals. Load the media correctly. If the media is loaded incorrectly, it might skew, causing unclear images. See Load originals for more information. Use or make a carrier sheet to protect your originals. |
| | Check the HP Fax | The ADF might need cleaning. See Clean the HP Fax for more information. |
| Error messages appear | Reload document and then restart job | Press the OK button, and then reload the remaining documents (up to 20 pages) in the ADF. For more information see Load originals . |

| Problem | Defects | More information |
|--|---|---|
| Copy defects are apparent | Vertical white or faded stripes | The media might not meet Hewlett-Packard media specifications (for example, the media is too moist or too rough). See Select print media for more information. |
| | Too light or dark | Try adjusting the contrast and copy-quality settings. |
| | Unwanted lines | The ADF might need cleaning. See Clean the HP Fax for more information. |
| | Black dots or streaks | Ink, glue, correction fluid, or an unwanted substance might be on the ADF. Try cleaning the HP Fax. See Clean the HP Fax for more information. |
| | Unclear text | <ul style="list-style-type: none"> Try adjusting the contrast and copy-quality settings. The default enhancement setting might not be suitable for the job. Check the setting and change it to enhance text or images, if needed. For more information, see Adjust the lightness and darkness of your copy. |
| | Incompletely filled text or graphics | Try adjusting the contrast and copy-quality settings. |
| | Copy is slanted or skewed | <ul style="list-style-type: none"> Make sure that the input tray is not too full. Make sure that the paper-width adjusters are snug against the sides of the media. |
| | Large, black typefaces look splotchy (not smooth) | The default enhancement setting might not be suitable for the job. Check the setting and change it to enhance text or images, if needed. For more information, see Change the copy settings . |
| Horizontal grainy or white bands in light-gray to medium-gray areas | The default enhancement setting might not be suitable for the job. Check the setting and change it to enhance text or images, if needed. For more information, see Change the copy settings . | |

Solve fax problems

| Problem | Possible solution |
|--|---|
| The display always shows Phone Off Hook | You are using the wrong type of phone cord. Make sure you are using the phone cord that came with the HP Fax to connect the HP Fax to your phone line. If the phone cord that came with the HP Fax is not long enough, you can use a coupler to extend the length. You can purchase a coupler at an electronics store that carries phone accessories. You will also need another phone cord, which can be a standard phone cord that you might already have in your home or office. |
| | Other equipment that uses the same phone line as the HP Fax might be in use. Make sure extension phones (phones on the same phone line, but not connected to the HP Fax) or other equipment are not in use or off the hook. For example, you cannot use the HP Fax for faxing if an |

(continued)

| Problem | Possible solution |
|--|---|
| <p>The HP Fax is having problems sending and receiving faxes</p> | <p>extension phone is off the hook, or if you are using a computer dial-up modem to send e-mail or access the Internet.</p> <p>Make sure the HP Fax is plugged in. Look at the display on the HP Fax. If the display is blank the HP Fax is unplugged. Make sure the power cord is firmly connected to the HP Fax and plugged into a power outlet.</p> <p>After plugging in the power cord, HP recommends you wait five minutes before sending or receiving a fax. The HP Fax cannot send or receive faxes while it is initializing after being plugged in.</p> <ul style="list-style-type: none"> • Check to see if another process has caused an error. Check the display for an error message providing information about the problem and how to solve it. If there is an error, the HP Fax will not send or receive a fax until the error condition is resolved. • The phone line connection might be noisy. Phone lines with poor sound quality (noise) can cause faxing problems. Check the sound quality of the phone line by plugging a phone into the telephone wall jack and listening for static or other noise. If you hear noise, turn Error Correction Mode (ECM) off and try faxing again. For information about changing ECM, see Send a fax in Error Correction Mode. If the problem persists, contact your telephone company. • If you are using a digital subscriber line (DSL) service, make sure that you have a DSL filter connected or you will not be able to fax successfully. • If you are using either a private branch exchange (PBX) or an integrated services digital network (ISDN) converter/terminal adapter, make sure the HP Fax is connected to the correct port and the terminal adapter is set to the correct switch type for your country/region, if possible. • If the HP Fax shares the same phone line with a DSL service, the DSL modem might not be properly grounded. If the DSL modem is not properly grounded, it can create noise on the phone line. Phone lines with poor sound quality (noise) can cause faxing problems. You can check the sound quality of the phone line by plugging a phone into the telephone wall jack and listening for static or other noise. If you hear noise, turn off your DSL modem and completely remove power for at least 15 minutes. Turn the DSL modem back on and listen to the dial tone again. <p>NOTE: You might notice static on the phone line again in the future. If the HP Fax stops sending and receiving faxes, repeat this process.</p> <p>If the phone line is still noisy, contact your telephone company. For information on turning your DSL modem off, contact your DSL provider for support.</p> |

(continued)

| Problem | Possible solution |
|---|--|
| The HP Fax is having problems sending a manual fax | <p>NOTE: This possible solution applies only in the countries/regions that receive a 2-wire phone cord in the box with the HP Fax, including: Argentina, Australia, Brazil, Canada, Chile, China, Colombia, Greece, India, Indonesia, Ireland, Japan, Korea, Latin America, Malaysia, Mexico, Philippines, Poland, Portugal, Russia, Saudi Arabia, Singapore, Spain, Taiwan, Thailand, USA, Venezuela, and Vietnam.</p> <ul style="list-style-type: none">• Make sure the telephone you use to initiate the fax call is connected directly to the HP Fax. To send a fax manually, the telephone must be connected directly to the port labeled 2-EXT on the HP Fax.• If you are sending a fax manually from your phone that is connected directly to the HP Fax, you must use the keypad on the telephone to send the fax. You cannot use the keypad on the control panel of the HP Fax. <p>NOTE: If using a serial-type phone system, please connect your phone directly on top of the HP Fax cable which has a wall plug attached to it.</p> |
| The HP Fax cannot receive faxes, but can send faxes | <p>If you are not using a distinctive ring service, check to make sure that the Distinctive Ring feature on the HP Fax is set to All Rings. For more information, see Change the answer ring pattern for distinctive ring.</p> <p>If you select Tel mode, you will need to receive faxes manually; otherwise, the HP Fax will not receive the fax. For information on receiving faxes manually, see Receive a fax manually.</p> <p>If you have a voice mail service at the same phone number you use for fax calls, you must receive faxes manually, not automatically. This means that you must be available to respond in person to incoming fax calls. If you want to receive faxes automatically instead, contact your telephone company to subscribe to a distinctive ring service, or to obtain a separate phone line for faxing.</p> <p>If you have a computer dial-up modem on the same phone line with the HP Fax, check to make sure that the software that came with your modem is not set to receive faxes automatically. Modems that are set up to receive faxes automatically take over the phone line to receive all incoming faxes, which prevents the HP Fax from receiving fax calls.</p> |

(continued)

| Problem | Possible solution |
|---------|--|
| | <p>If you have an answering machine on the same phone line with the HP Fax, you might have one of the following problems:</p> <ul style="list-style-type: none"> • Your answering machine might not be set up properly with the HP Fax. • Your outgoing message might be too long or too loud to allow the HP Fax to detect fax tones, and the sending fax machine might disconnect. • Your answering machine might not have enough quiet time after your outgoing message to allow the HP Fax to detect fax tones. This problem is most common with digital answering machines. <p>The following actions might help solve these problems:</p> <ul style="list-style-type: none"> • When you have an answering machine on the same phone line you use for fax calls, try connecting the answering machine directly to the port labeled 2-EXT on the back of the HP Fax. • Make sure the HP Fax is set to receive faxes automatically. For information on setting up the HP Fax to receive faxes automatically, see Receive a fax. • Make sure the Rings to Answer setting is set to a greater number of rings than the answering machine. For more information, see Set the number of rings before answering. • Disconnect the answering machine and then try receiving a fax. If faxing is successful without the answering machine, the answering machine might be causing the problem. • Reconnect the answering machine and record your outgoing message again. Record a message that is approximately 10 seconds in duration. Speak slowly and at a low volume when recording your message. Leave at least 5 seconds of silence at the end of the voice message. There should be no background noise when recording this silent time. Try to receive a fax again. <p>NOTE: Some digital answering machines might not retain the recorded silence at the end of your outgoing message. Play back your outgoing message to check.</p> |
| | <p>If the HP Fax shares the same phone line with other types of phone equipment, such as an answering machine, a computer dial-up modem, or a multi-port switch box, the fax signal level might be reduced. The signal level can also be reduced if you use a splitter or connect extra cables to extend the length of your phone. A reduced fax signal can cause problems during fax reception.</p> |
| | <p>If you have a special ring pattern for your fax phone number (using a distinctive ring service through your telephone company), make sure that the Distinctive Ring feature on the HP Fax is set to match. For more information, see Change the answer ring pattern for distinctive ring.</p> |

(continued)

| Problem | Possible solution |
|--|--|
| The HP Fax cannot send faxes, but can receive faxes | <p>The HP Fax might be dialing too fast or too soon. You might need to insert some pauses in the number sequence. For example, if you need to access an outside line before dialing the phone number, insert a pause following the access number. If your number is 95555555, and 9 accesses an outside line, you might insert pauses as follows: 9-555-5555. To enter a pause in the fax number you are typing, press Redial/Pause, or press the Symbols button repeatedly, until a dash (-) appears on the display.</p> <p>You can also send the fax using monitor dialing. This enables you to listen to the phone line as you dial. You can set the pace of your dialing and respond to prompts as you dial. For more information, see Send a fax using monitor dialing.</p> <p>The number you entered when sending the fax is not in the proper format or the receiving fax machine is having problems. To check this, try calling the fax number from a telephone and listen for fax tones. If you cannot hear fax tones, the receiving fax machine might not be turned on or connected, or a voice mail service could be interfering with the recipient's phone line. You can also ask the recipient to check the receiving fax machine for any problems.</p> |
| Fax tones are recorded on my answering machine | <p>When you have an answering machine on the same phone line you use for fax calls, try connecting the answering machine directly to the port labeled 2-EXT on the back of the HP Fax. If you do not connect the answering machine as recommended, fax tones might be recorded on your answering machine.</p> <p>Make sure the HP Fax is set to receive faxes automatically and that the Rings to Answer setting is correct. The number of rings to answer for the HP Fax should be greater than the number of rings to answer for the answering machine. If the answering machine and the HP Fax are set to the same number of rings to answer, both devices answer the call and fax tones are recorded on the answering machine.</p> <p>Set your answering machine to a low number of rings and the HP Fax to answer in the maximum number of rings supported. (The maximum number of rings varies by country/region.) In this setup, the answering machine answers the call and the HP Fax monitors the line. If the HP Fax detects fax tones, the HP Fax receives the fax. If the call is a voice call, the answering machine records the incoming message. For more information, see Set the number of rings before answering.</p> |
| The phone cord that came with my HP Fax is not long enough | <p>If the phone cord that came with the HP Fax is not long enough, you can use a coupler to extend the length. You can purchase a coupler at an electronics store that carries phone accessories. You will also need another phone cord, which can be a standard phone cord that you might already have in your home or office.</p> |

(continued)

| Problem | Possible solution |
|---------|---|
| | <p>TIP: If the HP Fax came with a 2-wire phone cord adaptor, you can use it with a 4-wire phone cord to extend the length. For information on using the 2-wire phone cord adaptor, see the documentation that came with it.</p> <p>To extend your phone cord</p> <ol style="list-style-type: none"> Using the phone cord supplied in the box with the HP Fax, connect one end to the coupler, then connect the other end to the port labeled 1-LINE on the back of the HP Fax. Connect another phone cord to the open port on the coupler and to the telephone wall jack. |

Troubleshoot setup issues

| Problem | Possible solution | More information |
|----------------------------|---|---|
| Hardware setup suggestions | Check the HP Fax suggestions | <ul style="list-style-type: none"> Make sure that all packing tape and material have been removed from outside and inside the HP Fax. Make sure that the HP Fax is loaded with paper. If the Attention light is blinking, check for messages on the control panel. |
| | Check the hardware connections | <ul style="list-style-type: none"> Make sure that any cords and cables that you are using are in good working order. Make sure that the power cord is connected securely to both the HP Fax and to a working power outlet. Make sure that the phone cord is connected to the 1-LINE port. |
| | Check the print cartridges | <ul style="list-style-type: none"> Make sure the tape is removed from the print cartridges. Make sure that the print cartridges are firmly installed in their correct slot. Press down firmly on each one to ensure proper contact. |
| | Check the HP Fax to ensure the following: | <ul style="list-style-type: none"> When the HP Fax is first plugged in, it takes approximately 45 seconds to warm up. The HP Fax is in the Ready state, and no other lights on the control panel are lit or blinking. If the Attention light is lit or blinking, see the message on the control panel. Ensure power cord and other cables are working, and are firmly connected to the HP Fax. All packing tapes and materials are removed from the HP Fax. Rear access panel is locked into place. Paper is loaded correctly in the tray, and is not jammed in the HP Fax. |

Clear paper jams

If the paper was loaded in the input tray, you might need to clear the paper jam from the rear door.

Paper can also jam in the automatic document feeder. Several common actions can cause paper to jam the automatic document feeder:

- Placing too much paper in the document feeder tray.
- Using paper that is too thick or too thin for the HP Fax.
- Trying to add paper to the document feeder tray while the HP Fax is feeding pages.

To clear a paper jam from the rear door

1. Unplug the power cord.
2. Press in the tab on the left side of the rear door to release the door. Remove the door by pulling it away from the HP Fax.

△ **CAUTION:** Trying to clear a paper jam from the front of the HP Fax can damage the print mechanism. Always access and clear paper jams through the rear door.

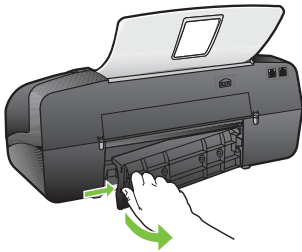

3. Gently pull the paper out of the rollers.

△ **CAUTION:** If the paper tears when you are removing it from the rollers, check the rollers and wheels for torn pieces of paper that might be remaining inside the HP Fax. If you do not remove all the pieces of paper from the HP Fax, more paper jams are likely to occur.

4. Replace the rear door. Gently push the door forward until it snaps into place.
5. Press **OK** to continue the current job.

To clear a paper jam in the automatic document feeder

1. Unplug the power cord.
2. Lift the cover of the automatic document feeder.

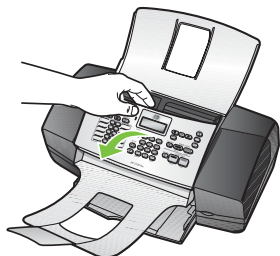

3. Gently pull the paper out of the rollers.

△ **CAUTION:** If the paper tears when you are removing it from the rollers, check the rollers and wheels for torn pieces of paper that might be remaining inside the HP Fax. If you do not remove all the pieces of paper from the HP Fax, more paper jams are likely to occur.

4. Close the cover of the automatic document feeder.

Avoid paper jams

To help avoid paper jams, follow these guidelines.

- Remove printed papers from the output tray frequently.
- Prevent curled or wrinkled paper by storing all unused paper flat in a resealable bag.
- Ensure that paper loaded in the input tray lays flat and the edges are not bent or torn.
- Do not combine different paper types and paper sizes in the input tray; the entire stack of paper in the input tray must be the same size and type.
- Adjust the paper-width guide in the input tray to fit snugly against all paper. Make sure the paper-width guide does not bend the paper in the input tray.
- Do not force paper too far forward in the input tray.
- Use paper types that are recommended for the HP Fax. For more information, see [Understand specifications for supported media](#).

A HP supplies and fax specifications

This section provides information on HP supplies and specifications for the HP Fax. The information is subject to change; visit the HP Web site (www.hpshopping.com) for the latest updates. You may also make purchases through the Web site.

- [Order printing supplies online](#)
- [Supplies](#)
- [Physical specifications](#)
- [Product features and capacities](#)
- [Memory specifications](#)
- [Print specifications](#)
- [Copy specifications](#)
- [Fax specifications](#)
- [Environmental specifications](#)
- [Electrical specifications](#)
- [Acoustic emission specifications \(noise levels per ISO 7779\)](#)

Order printing supplies online

To order genuine HP supplies for the HP Fax, go to www.hpshopping.com. If prompted, choose your country/region, follow the prompts to select your product, and then click one of the shopping links on the page.

Supplies

- [HP media](#)
- [Print cartridges](#)

HP media

To order media such as HP Premium Plus Photo Paper or HP Premium Paper, go to www.hpshopping.com.

For media and media-handling specifications, see [Understand specifications for supported media](#).

Print cartridges

You can find the cartridge number on the label of the print cartridge you are replacing.

The HP Fax uses the following print cartridges:

- HP 21 black inkjet print cartridge
- HP 22 tri-color inkjet print cartridge
- HP 54 black inkjet print cartridge

 **NOTE:** Ink from the cartridges is used in the printing process in a number of different ways, including in the initialization process, which prepares the HP Fax and cartridges for printing. In addition, some residual ink is left in the cartridge after it is used. For more information see www.hp.com/go/inkusage.

NOTE: Ordering print cartridges online is not supported in all countries/regions. If it is not supported in your country/region, contact a local HP reseller for information about purchasing print cartridges.

Physical specifications

- Height: 330.2 mm (13 inches)
- Width: 425.5 mm (16.75 inches)
- Depth: 203.2 mm (8 inches)
- Weight: 5.5 kg (12 pounds)

Product features and capacities

| Feature | Capacity |
|------------------|--|
| Print cartridges | Black and tri-color print cartridges |
| Supply yields | Visit www.hp.com/pageyield/ for more information on estimated print cartridge yields. |
| HP Fax languages | HP PCL 3 enhanced |
| Font support | US fonts: CG Times, CG Times Italic, Universe, Universe Italic, Courier, Courier Italic, Letter Gothic, Letter Gothic Italic. |
| Duty cycle | Up to 1000 pages per month |

Memory specifications

HP Fax memory

2 MB ROM, 16 MB RAM

Print specifications

- Resolution: 1200 x 1200 dpi black, 4800 optimized dpi color
- Method: drop-on-demand thermal inkjet
- Language: Lightweight Imaging Device Interface Language (LIDIL)

Copy specifications

- Digital image processing
- Up to 99 copies from original (varies by model)
- Digital zoom: from 25 to 400% (varies by model)
- Fit to page, pre-scan

| Mode | Type | Scan resolution (dpi) |
|--------|-------|-----------------------|
| Best | Black | up to 600 x 1200 |
| | Color | up to 600 x 1200 |
| Normal | Black | up to 300 x 300 |
| | Color | up to 300 x 300 |
| Fast | Black | up to 300 x 300 |
| | Color | up to 300 x 300 |

Fax specifications

- Walk-up black-and-white and color fax capability
- Up to 200 speed dials
- Up to 300-page memory (varies by model, based on ITU-T Test Image #1 at standard resolution more complicated pages or higher resolution pages take longer and use more memory)
- Manual fax send and receive
- Automatic busy redial up to five times
- Automatic no-answer redial one time (varies by model)
- Confirmation and activity reports
- CCITT/ITU Group 3 fax with Error Correction Mode
- 33.6 Kbps transmission
- Ring detect with automatic fax/answering machine switching

| | Photo (dpi) | Very Fine (dpi) | Fine (dpi) | Standard (dpi) |
|-------|-----------------------------|-----------------|------------|----------------|
| Black | 196 x 203 (8-bit grayscale) | 300 x 300 | 196 x 203 | 196 x 98 |
| Color | 200 x 200 | 200 x 200 | 200 x 200 | 200 x 200 |

Environmental specifications

Operating environment

Operating temperature: 5° to 40° C (41° to 104° F)

Recommended operating conditions: 15° to 32° C (59° to 90° F)

Recommended relative humidity: 15 to 80% noncondensing

Storage environment

Storage temperature: -40° to 60° C (-40° to 140° F)

Storage relative humidity: Up to 90% noncondensing at a temperature of 65° C (150° F)

Electrical specifications

Power requirements

External AC adaptor input (max): 100 to 240 VAC ($\pm 10\%$), 50/60 Hz ($\pm 3\text{Hz}$)

System DC input (max): 15 Vdc or 16 Vdc at 400 mA; 32 Vdc at 500 mA

 **NOTE:** The AC adaptor shipped might be specified to provide more power than system DC input (max) requirement above.

Acoustic emission specifications (noise levels per ISO 7779)

- Sound pressure (bystander position)
 - Color printing: LpAd 42 (dBA)
 - Black-and-white printing and copying: LpAd 47 (dBA)
 - Black-and-white printing (Fast mode): LpAd 52 (dBA)
 - Sending black-and-white fax: LpAd 40 (dBA)
 - Idle: LpAd 21 (dBA)
- Sound power
 - Color printing: LwAd 5.5 (BA)
 - Black-and-white printing and copying: LwAd 5.9 (BA)

Appendix A

- Black-and-white printing (Fast mode): LwAd 6.4 (BA)
- Sending black-and-white fax: LwAd 5.3 (BA)
- Idle: LwAd 3.3 (BA)

B Support and warranty

The information in [Maintain and troubleshoot](#) suggests solutions to common problems. If your HP Fax is not operating correctly and those suggestions did not solve your problem, try using one of the following support services to obtain assistance.

- [Obtain electronic support](#)
- [Obtain HP telephone support](#)
- [Prepare the HP Fax for shipment](#)
- [Pack the HP Fax](#)
- [Warranty](#)

Obtain electronic support

To find support and warranty information, go to the HP Web site at www.hp.com/support. If prompted, choose your country/region, and then click **Contact HP** for information on calling for technical support.

This Web site also offers technical support, supplies, ordering information and other options such as:

- Access online support pages.
- Send HP an e-mail message for answers to your questions.
- Connect with an HP technician by using online chat.

Support options and availability vary by product, country/region, and language.

Obtain HP telephone support

During the warranty period, you may obtain assistance from the HP Customer Care Center.

This section contains the following topics:

- [Before you call](#)
- [Support process](#)
- [HP support by phone](#)
- [Additional warranty options](#)

Before you call

Visit the HP Web site (www.hp.com/support) for the latest troubleshooting information, or product fixes and updates.

To assist our Customer Care Center representatives to serve you better, prepare the following information if you need to call HP.

- ▲ If the HP Fax does not print, get the following information ready:
 - HP Fax model
 - Model number and serial number (check the back of the HP Fax)

Support process

If you have a problem, follow these steps:

1. Check the documentation that came with the HP Fax.
2. Visit the HP online support Web site at www.hp.com/support. HP online support is available to all HP customers. It is the fastest source for up-to-date HP Fax information and expert assistance and includes the following features:
 - Fast access to qualified online support specialists
 - Valuable troubleshooting information for common problems
 - Proactive HP Fax updates, support alerts, and HP newsgrams that are available when you register the HP Fax
3. Call HP support. Support options and availability vary by product, country/region, and language.

HP support by phone

This section contains the following topics:

- [Phone support period](#)
- [Placing a call](#)
- [After the phone support period](#)

Phone support period

One year of phone support is available in North America, Asia Pacific, and Latin America (including Mexico). For the most current list of telephone support numbers, go to www.hp.com/support.

Placing a call

Call HP support while you are in front of the HP Fax. Be prepared to provide the following information:

- Model number (located on the label on the front of the HP Fax)
- Serial number (located on the back or bottom of the HP Fax)
- Messages that appear when the situation occurs
- Answers to these questions:
 - Has this situation happened before?
 - Can you re-create it?
 - Did anything else occur prior to this situation (such as a thunderstorm, HP Fax was moved, etc.)?

After the phone support period

After the phone support period, help is available from HP at an additional cost. Help may also be available at the HP online support Web site: www.hp.com/support. Contact your HP dealer or call the support phone number for your country/region to learn more about support options.

Additional warranty options

Extended service plans are available for the HP Fax at additional costs. Go to www.hp.com/support, select your country/region and language, then explore the services and warranty area for information about the extended service plans.

Prepare the HP Fax for shipment

If after contacting HP Customer Support or returning to the point of purchase, you are requested to send the HP Fax in for service, make sure you remove and keep the following items before returning your HP Fax:

- The print cartridges
- The power cord and any other cable connected to the HP Fax

- Any paper loaded in the input tray
- Remove any originals you might have loaded in the HP Fax

Pack the HP Fax

Complete the following steps after you have prepared the HP Fax for shipment.

To pack the HP Fax

1. If available, pack the HP Fax for shipment by using the original packaging materials, or use the packaging materials that came with your replacement HP Fax.
If you do not have the original packaging materials, please use other adequate packaging materials. Shipping damage caused by improper packaging and/or improper transportation is not covered under the warranty.
2. Place the return shipping label on the outside of the box.
3. Include the following items in the box:
 - A complete description of symptoms for service personnel (samples of print quality problems are helpful).
 - A copy of the sales slip or other proof of purchase to establish the warranty coverage period.
 - Your name, address, and a phone number where you can be reached during the day.

Warranty

| HP product | Duration of limited warranty |
|-------------------------|---|
| Fax | 1 year |
| Print or Ink cartridges | Until the HP ink is depleted or the "end of warranty" date printed on the cartridge has been reached, whichever occurs first. This warranty does not cover HP ink products that have been refilled, remanufactured, refurbished, misused, or tampered with. |
| Accessories | 1 year unless otherwise stated |

A. Extent of limited warranty

- Hewlett-Packard (HP) warrants to the end-user customer that the HP products specified above will be free from defects in materials and workmanship for the duration specified above, which duration begins on the date of purchase by the customer.
- For software products, HP's limited warranty applies only to a failure to execute programming instructions. HP does not warrant that the operation of any product will be interrupted or error free.
- HP's limited warranty covers only those defects that arise as a result of normal use of the product, and does not cover any other problems, including those that arise as a result of:
 - Improper maintenance or modification;
 - Software, media, parts, or supplies not provided or supported by HP;
 - Operation outside the product's specifications;
 - Unauthorized modification or misuse.
- For HP printer products, the use of a non-HP cartridge or a refilled cartridge does not affect either the warranty to the customer or any HP support contract with the customer. However, if printer failure or damage is attributable to the use of a non-HP or refilled cartridge or an expired ink cartridge, HP will charge its standard time and materials charges to service the printer for the particular failure or damage.
- If HP receives, during the applicable warranty period, notice of a defect in any product which is covered by HP's warranty, HP shall either repair or replace the product, at HP's option.
- If HP is unable to repair or replace, as applicable, a defective product which is covered by HP's warranty, HP shall, within a reasonable time after being notified of the defect, refund the purchase price for the product.
- HP shall have no obligation to repair, replace, or refund until the customer returns the defective product to HP.
- Any replacement product may be either new or like-new, provided that it has functionality at least equal to that of the product being replaced.
- HP products may contain remanufactured parts, components, or materials equivalent to new in performance.
- HP's Limited Warranty Statement is valid in any country where the covered HP product is distributed by HP. Contracts for additional warranty services, such as on-site service, may be available from any authorized HP service facility in countries where the product is distributed by HP or by an authorized importer.

B. Limitations of warranty

TO THE EXTENT ALLOWED BY LOCAL LAW, NEITHER HP NOR ITS THIRD PARTY SUPPLIERS MAKES ANY OTHER WARRANTY OR CONDITION OF ANY KIND, WHETHER EXPRESS OR IMPLIED WARRANTIES OR CONDITIONS OF MERCHANTABILITY, SATISFACTORY QUALITY, AND FITNESS FOR A PARTICULAR PURPOSE.

C. Limitations of liability

- To the extent allowed by local law, the remedies provided in this Warranty Statement are the customer's sole and exclusive remedies.
- TO THE EXTENT ALLOWED BY LOCAL LAW, EXCEPT FOR THE OBLIGATIONS SPECIFICALLY SET FORTH IN THIS WARRANTY STATEMENT, IN NO EVENT SHALL HP OR ITS THIRD PARTY SUPPLIERS BE LIABLE FOR DIRECT, INDIRECT, SPECIAL, INCIDENTAL, OR CONSEQUENTIAL DAMAGES, WHETHER BASED ON CONTRACT, TORT, OR ANY OTHER LEGAL THEORY AND WHETHER ADVISED OF THE POSSIBILITY OF SUCH DAMAGES.

D. Local law

- This Warranty Statement gives the customer specific legal rights. The customer may also have other rights which vary from state to state in the United States, from province to province in Canada, and from country to country elsewhere in the world.
- To the extent that this Warranty Statement is inconsistent with local law, this Warranty Statement shall be deemed modified to be consistent with such local law. Under such local law, certain disclaimers and limitations of this Warranty Statement may not apply to the customer. For example, some states in the United States, as well as some governments outside the United States (including provinces in Canada), may:
 - Preclude the disclaimers and limitations in this Warranty Statement from limiting the statutory rights of a consumer (e.g., the United Kingdom);
 - Otherwise restrict the ability of a manufacturer to enforce such disclaimers or limitations; or
 - Grant the customer additional warranty rights, specify the duration of implied warranties which the manufacturer cannot disclaim, or allow limitations on the duration of implied warranties.
- THE TERMS IN THIS WARRANTY STATEMENT, EXCEPT TO THE EXTENT LAWFULLY PERMITTED, DO NOT EXCLUDE, RESTRICT, OR MODIFY, AND ARE IN ADDITION TO, THE MANDATORY STATUTORY RIGHTS APPLICABLE TO THE SALE OF THE HP PRODUCTS TO SUCH CUSTOMERS.

HP Limited Warranty

Dear Customer,

You will find below the name and address of the HP entity responsible for the performance of the HP Limited Warranty in your country.

You may have additional statutory rights against the seller based on your purchase agreement. Those rights are not in any way affected by this HP Limited Warranty.

Ireland: Hewlett-Packard Ireland Ltd, 30 Herbert Street IRL-Dublin 2

United Kingdom: Hewlett-Packard Ltd, Cain Road, Bracknell, GB-Berks RG12 1HN

C Regulatory information

The HP Fax meets product requirements from regulatory agencies in your country/region.

This section contains the following topics:

- [FCC statement](#)
- [Noise emission statement for Germany](#)
- [Notice to users of the U.S. telephone network: FCC requirements](#)
- [Notice to users of the Canadian telephone network](#)
- [Notice to users in the European Economic Area](#)
- [Regulatory model number](#)
- [Environmental product stewardship program](#)
- [Declaration of conformity](#)

FCC statement

FCC statement

The United States Federal Communications Commission (in 47 CFR 15.105) has specified that the following notice be brought to the attention of users of this product.

This equipment has been tested and found to comply with the limits for a Class B digital device, pursuant to part 15 of the FCC Rules. Operation is subject to the following two conditions: (1) this device may not cause harmful interference, and (2) this device must accept any interference received, including interference that may cause undesired operation. Class B limits are designed to provide reasonable protection against harmful interference in a residential installation. This equipment generates, uses, and can radiate radio frequency energy, and, if not installed and used in accordance with the instructions, may cause harmful interference to radio communications. However, there is no guarantee that interference will not occur in a particular installation. If this equipment does cause harmful interference to radio or television reception, which can be determined by turning the equipment off and on, the user is encouraged to try to correct the interference by one or more of the following measures:

- Reorient the receiving antenna.
- Increase the separation between the equipment and the receiver.
- Connect the equipment into an outlet on a circuit different from that to which the receiver is connected.
- Consult the dealer or an experienced radio/TV technician for help.

The user may find the following booklet prepared by the Federal Communications Commission helpful: How to Identify and Resolve Radio-TV Interference Problems. This booklet is available from the U.S. Government Printing Office, Washington DC, 20402. Stock No. 004-000-00345-4.

CAUTION: Pursuant to Part 15.21 of the FCC Rules, any changes or modifications to this equipment not expressly approved by the Hewlett-Packard Company, may cause harmful interference and void the FCC authorization to operate this equipment.

Noise emission statement for Germany

Geräuschemission

LpA < 70 dB am Arbeitsplatz im Normalbetrieb nach DIN 45635 T. 19

Notice to users of the U.S. telephone network: FCC requirements

This equipment complies with Part 68 of the FCC rules and the requirements adopted by the ACTA. On the back of this equipment is a label that contains, among other information, a product identifier in the format US:AAAEQ##TXXXX. If requested, this number must be provided to the telephone company.

The HP 3100 Fax series is provided with a RJ11C connector for connecting this product to the telephone network. An additional RJ11C connector is provided for connecting an additional device to the telephone network from the HP 3100 Fax series.

A plug and jack used to connect this equipment to the premises wiring and telephone network must comply with the applicable FCC Part 68 rules and requirements adopted by the ACTA. A compliant telephone cord and modular plug is provided with this product. It is designed to be connected to a compatible modular jack that is also compliant. See installation instructions for details.

The REN is used to determine the number of devices that may be connected to a telephone line. Excessive RENs on a telephone line may result in the devices not ringing in response to an incoming call. In most but not all areas, the sum of RENs should not exceed five (5.0). To be certain of the number of devices that may be connected to a line, as determined by the total RENs, contact the local telephone company. For products approved after July 23, 2001, the REN for this product is part of the product identifier that has the format US:AAAEQ##TXXXX. The digits represented by ## are the REN without a decimal point (e.g., 03 is a REN of 0.3). For earlier products, the REN is separately shown on the label.

If the HP 3100 Fax series causes harm to the telephone network, the telephone company will notify you in advance that temporary discontinuance of service may be required. But if advance notice isn't practical, the telephone company will notify the customer as soon as possible. Also, you will be advised of your right to file a complaint with the FCC if you believe it is necessary.

The telephone company may make changes in its facilities, equipment, operations or procedures that could affect the operation of the equipment. If this happens, the telephone company will provide advance notice in order for you to make necessary modifications to maintain uninterrupted service.

There are no customer serviceable parts inside the HP 3100 Fax series. If trouble is experienced with the HP 3100 Fax series, for repair or warranty information, please contact Hewlett-Packard technical support by calling 866-331-9600. If you have Internet access, you can go to www.hp.com/support for more information on the HP 3100 Fax series.

If the equipment is causing harm to the telephone network, the telephone company may request that you disconnect the equipment until the problem is resolved.

Connection to party line service is subject to state tariffs. Contact the state public utility commission, public service commission or corporation commission for information.

If your home has specially wired alarm equipment connected to the telephone line, ensure the installation of HP 3100 Fax series does not disable your alarm equipment. If you have questions about what will disable alarm equipment, consult your telephone company or a qualified installer.

This equipment is hearing aid compatible.

HP recommends the use of a Surge Suppressor when connecting the HP 3100 Fax series to AC power. Use of a Surge Suppressor will help protect the HP 3100 Fax series and the telephone network from abnormal surges on the AC powerline.

The Customer Information for facsimile (FAX) equipment must contain the following wording:

The Telephone Consumer Protection Act of 1991 makes it unlawful for any person to use a computer or other electronic device, including FAX machines, to send any message unless such message

clearly contains in a margin at the top or bottom of each transmitted page or on the first page of the transmission, the date and time it is sent and an identification of the business or other entity, or other individual sending the message and the telephone number of the sending machine or such business, other entity, or individual. (The telephone number provided may not be a 900 number or any other number for which charges exceed local or long-distance transmission charges.)

In order to program this information into your FAX machine, see [Configure the fax header](#).

Automatic Dialers

WHEN PROGRAMMING EMERGENCY NUMBERS AND (OR) MAKING TEST CALLS TO EMERGENCY NUMBERS:

1. Remain on the line and briefly explain to the dispatcher the reason for the call.
2. Perform such activities in the off-peak hours, such as early morning or late evenings.

Notice to users of the Canadian telephone network

Notice to users of the Canadian telephone network/Note à l'attention des utilisateurs du réseau téléphonique Canadien

This product meets the applicable Industry Canada technical specifications/Le présent matériel est conforme aux spécifications techniques applicables d'Industrie Canada.

The Ringer Equivalence Number is an indication of the maximum number of devices allowed to be connected to a telephone interface. The termination on an interface may consist of any combination of devices subject only to the requirement that the sum of the RENs of all the devices does not exceed five/L'indice d'équivalence de la sonnerie (IES) sert à indiquer le nombre maximal de terminaux qui peuvent être raccordés à une interface téléphonique. La terminaison d'une interface peut consister en une combinaison quelconque de dispositifs, à la seule condition que la somme d'indices d'équivalence de la sonnerie de tous les dispositifs n'excède pas 5.

Notice to users in the European Economic Area

Notice to users in the European Economic Area



This product is designed to be connected to the analog Switched Telecommunication Networks (PSTN) of the European Economic Area (EEA) countries/regions.

Network compatibility depends on customer selected settings, which must be reset to use the equipment on a telephone network in a country/region other than where the product was purchased. Contact the vendor or Hewlett-Packard Company if additional product support is necessary.

This equipment has been certified by the manufacturer in accordance with Directive 1999/5/EC (annex II) for Pan-European single-terminal connection to the public switched telephone network (PSTN). However, due to differences between the individual PSTNs provided in different countries, the approval does not, of itself, give an unconditional assurance of successful operation on every PSTN network termination point.

In the event of problems, you should contact your equipment supplier in the first instance.

This equipment is designed for DTMF tone dialing and loop disconnect dialing. In the unlikely event of problems with loop disconnect dialing, it is recommended to use this equipment only with the DTMF tone dial setting.

Regulatory model number

For regulatory identification purposes, your product is assigned a Regulatory Model Number. The Regulatory Model Number for your product is SNPRG-0702. This regulatory number should not be confused with the marketing name (HP 3100 Fax series) or product number.

Environmental product stewardship program

Hewlett-Packard is committed to providing quality products in an environmentally sound manner. Design for recycling has been incorporated into this product. The number of materials has been kept to a minimum while ensuring proper functionality and reliability. Dissimilar materials have been designed to separate easily. Fasteners and other connections are easy to locate, access, and remove using common tools. High priority parts have been designed to access quickly for efficient disassembly and repair.

For more information, visit HP's Commitment to the Environment Web site at:

www.hp.com/hpinfo/globalcitizenship/environment/index.html

This section contains the following topics:

- [Paper use](#)
- [Plastics](#)
- [Material safety data sheets](#)
- [Energy consumption](#)
- [Recycling program](#)
- [HP inkjet supplies recycling program](#)
- [Disposal of waste equipment by users in private households in the European Union](#)

Paper use

This product is suited for the use of recycled paper according to DIN 19309 and EN 12281:2002.

Plastics

Plastic parts over 25 grams are marked according to international standards that enhance the ability to identify plastics for recycling purposes at the end of product life.

Material safety data sheets

Material safety data sheets (MSDS) can be obtained from the HP Web site at:

www.hp.com/go/msds

Energy consumption

This product is designed to reduce power consumption and save natural resources without compromising product performance. It has been designed to reduce total energy consumption both during operation and when the HP Fax is not active. Specific information on power consumption may be found in the printed documentation that came with the HP Fax.

Recycling program

HP offers an increasing number of product return and recycling programs in many countries/regions, and partners with some of the largest electronic recycling centers throughout the world. HP conserves resources by reselling some of its most popular products. For more information regarding recycling of HP products, please visit:

www.hp.com/hpinfo/globalcitizenship/environment/recycle/

HP inkjet supplies recycling program

HP is committed to protecting the environment. The HP Inkjet Supplies Recycling Program is available in many countries/regions, and lets you recycle used print cartridges and ink cartridges free of charge. For more information, go to the following Web site:

www.hp.com/hpinfo/globalcitizenship/environment/recycle/

Declaration of conformity



DECLARATION OF CONFORMITY

according to ISO/IEC 17050-1 and EN 17050-1

DoC #: SNPRG-0702

Supplier's Name: Hewlett-Packard Company
Emerging Markets, Fax & OEM Division
Supplier's Address: 61 Alexandra Terrace
#08-01 Harbour Link
Singapore 119936

Declares, that the product:
Product Name and Model: HP 3100 Fax (CB820A) series
Regulatory Model Number: SNPRG-0702
Product Options: All
conforms to the following Product Specifications and Regulations:

EMC: Class B
FCC Part 15 Subpart B
EN 55022 : 1998 +A1:2000 +A2:2003
EN 55024 : 1998 +A1:2001 +A2:2003
EN 61000-3-2:2000 +A2:2005
EN 61000-3-3:1995 +A1:2001

Safety:
UL 60950-1
CAN/CSA-C22.2 No. 60950-1-03, First Edition.
EN 60950-1:2001
IEC 60950-1:2001

Telecom:
FCC Part 68 and TIA-968-A-1 + A-2 + A-3 standard
IC CS-03 standard (Issue 9)
ES 203 021
TBR21:1998

This device complies with part 15 of the FCC Rules. Operation is subject to the following two conditions: (1) This device may not cause harmful interference, and (2) this device must accept any interference received, including interference that may cause undesired operation.
The product herewith complies with the requirements of the Low Voltage Directive 2006/95/EC, the EMC Directive 2004/108/EC and the R&TTE Directive 99/5/EC, and carries the CE-marking accordingly.

Additional Information:
This product is assigned a Regulatory Model Number which stays with the regulatory aspects of the design. The Regulatory Model Number is the main product identifier in the regulatory documentation and test reports, this number should not be confused with the marketing name or the product numbers.

Manager

Local contact for regulatory topics only:
U.S.: Hewlett-Packard, 3000 Hanover St., Palo Alto 94304, U.S.A. 650-857-1501
EMEA: Hewlett-Packard GmbH, HQ-TRE, Herrenberger Strasse 140, 71034 Boeblingen, Germany

Index

- A**
 - A4 paper, load 8
 - acoustic emissions 75
 - ADF (automatic document feeder)
 - capacity 10
 - media sizes supported 21
 - administrator
 - settings 44
 - after the support period 78
 - align print cartridges 55
 - answer ring pattern
 - change 36
 - answering machine
 - fax tones recorded 69
 - attention light 7
 - automatic document feeder (ADF)
 - capacity 10
 - media sizes supported 21
 - automatic fax reduction 33
- B**
 - Back button 7
 - backup fax reception 30
 - baud rate 37
 - best copy quality 41
 - black and white pages
 - copy 39
 - fax 22
 - black dots or streaks, troubleshoot
 - copies 65
 - blank pages, troubleshoot
 - copy 63
 - print 61
 - blocked fax numbers
 - set up 33
 - broadcast faxing
 - send 25
 - buttons, control panel 7
- C**
 - cancel
 - button 8
 - copy
 - copy 43
 - scheduled fax 25
 - capacity
 - ADF 10
 - trays 21
 - cartridges. *See* print cartridges
 - clean
 - exterior 61
 - fax 59
 - glass strip 59
 - print cartridge contacts 56
 - print cartridge ink nozzle
 - area 57
 - print cartridges 55
 - white strip 60
 - color
 - copies 43
 - fax 26
 - color copy 39
 - colors
 - bleeding 62
 - confirmation reports, fax 44
 - connectors, locating 6
 - contrast, fax 28
 - control panel
 - buttons 7
 - copy from 39
 - enter text and symbols 17
 - lights 7
 - locating 6
 - menus 16
 - messages 16
 - reports 7
 - send faxes 12
 - settings, change 11
 - copy
 - button 8
 - cancel 43
 - enhance light areas 43
 - from the control panel 39
 - images/embedded pictures,
 - enhance 42
 - legal to letter 42
 - number of copies 40
 - paper size 40
 - paper types,
 - recommended 40
 - quality 41, 64
 - reduce 42
 - settings 39
 - specifications 74
 - speed 41
 - text, enhance 42
 - troubleshoot 63
 - Copy menu 16
 - correct port test, fax 48
 - critical error messages 17
 - customer support
 - electronic 77
 - phone support 77
 - warranty 78
- D**
 - dark images, troubleshoot
 - copies 65
 - darken
 - copies 42
 - faxes 28
 - Declaration of Conformity (DOC) 87
 - default settings
 - control panel 11
 - copy 39
 - fax 28
 - deleting faxes from memory 31
 - dial tone test, failure 49
 - dial type, setting 36
 - distinctive ringing
 - change 36
 - documentation 5
 - dots or streaks, troubleshoot
 - copies 65
 - duty cycle 74
- E**
 - ECM. *See* error correction mode
 - electrical specifications 75
 - enhance
 - copy, images/embedded pictures 42
 - environmental specifications 75

Index

environmental sustainability program 84
error correction mode 29
error messages
 control panel 16
error reports, fax 45
error-correction mode, fax 36

F

faded copies 64
faded stripes on copies, troubleshoot 65
fast copy quality 41
fax
 answer mode 8, 12
 answering machine troubleshoot 69
 backup fax reception 30
 blocking numbers 33
 button 8
 clean 59
 confirmation reports 44
 contrast 28
 darken or lighten 28
 default settings 28
 deleting from memory 31
 dial tone test, failed 49
 dial type, setting 36
 distinctive ringing, change pattern 36
 enter text and symbols 17
 error correction mode 29
 error reports 45
 error-correction mode 36
 forwarding 32
 header 35
 images/embedded pictures 26
 Internet, over 38
 lighten or darken 28
 line condition test, failed 50
 log, print 45
 manual receive 29
 monitor dialing 24, 25
 paper size 32
 parallel phone systems 13
 pause 17
 phone cord connection test, failed 48
 phone cord too short 69
 phone cord type test, failed 49
 poll to receive 31

receive 29
receive, troubleshoot 66, 67
redial options 37
reduction 33
reports 44
reprint 31
resolution 27
rings to answer 35
schedule 25
send 22
send, troubleshoot 66, 67, 69
set up 12
settings 27
settings, change 35
specifications 75
speed 37
speed-dial entries, set up 19
speed-dial groups, set up 19
test failed 46
test setup 46
troubleshoot 65
wall jack test, failed 47

Fax menu 16
fax port, locating 6
Fax Resolution 7
fit to page 41
FoIP 38
fonts supported 74
forwarding faxes 32

G

glass strip
 clean 59
grainy or white bands on copies, troubleshoot 65
graphics
 incompletely filled on copies 65
 missing lines or dots 62
groups, speed-dial set up 19

H

hardware, fax setup test 47
header, fax 35
help 77
 see also customer support

Hewlett-Packard Company notices 3
humidity specifications 75

I

image/embedded picture fax 26
image/embedded pictures enhance copies 43
Internet
 fax, using 38

J

jams
 media to avoid 20
jams, paper 72
jobs
 settings 11
junk fax mode 33

K

keypad 8
keypad, control panel enter text and symbols 17

L

language, HP Fax 74
left arrow 8
legal paper
 copy 40
 load 8
letter paper
 copy 40
 load 8
light images, troubleshoot copies 65
lighten
 copies 42
 faxes 28
Lighter/Darker 7
lights, control panel 7
line condition test, fax 50
lines
 copies, troubleshoot 65
load
 A4 paper 8
 full-size paper 8
 legal paper 8
 letter paper 8
 originals in ADF (automatic document feeder) 10

log, fax
print 45

M

maintenance
align print cartridges 55
clean glass strip 59
clean print cartridges 55
clean white strip 60
replace print cartridges 52

manual faxing
receive 29
send 22, 24

margins
setting, specifications 21

media
ADF capacity 10
HP, order 73
selecting 20
skewed pages 63
specifications 21
supported sizes 21
troubleshoot feeding 63
types and weights
supported 21

memory
deleting faxes 31
reprint faxes 31
save faxes 30
specifications 74

menus, control panel 16

missing lines or dots,
troubleshoot 62

monitor dialing 24, 25

multi-feeds, troubleshoot 63

N

noise information 75
normal copy quality 41
number of copies 40

O

OK button 8
one-touch speed dial buttons 8
operating environment
specifications 75
originals
load ADF (automatic
document feeder) 10
output tray
locating 6

P

packing the HP Fax 79
pages per month (duty
cycle) 74

paper
jams 71, 72
legal to letter copy 42
recommended copy
types 40
size, set for fax 32

paper size
copy setting 40
paper-feed problems,
troubleshoot 63
parallel phone systems
countries/regions with 13

PCL 3 support 74

phone cord
connected to correct port
test failed 48
correct type test failed 49
extend 69

phone customer support 77

phone line, answer ring
pattern 36

phone support 78

phone support period
period for support 78

phone, fax from
receive 29
send, 22

photo media
guidelines 20

photo paper
copy 40

poll to receive fax 31

power
specifications 75
troubleshoot 61

power input, locating 6
print

fax logs 45
fax reports 44
faxes 31
speed-dial entries 20
troubleshoot 61

print cartridges
align 55
clean 55
clean contacts 56
clean ink nozzle area 57
handle 52
order online 73

part names 52
part numbers 51, 73
replace 52
supported 74
yields 74

print quality
troubleshoot 62
processor specifications 74
pulse dialing 36

Q

quality, copy 41
quality, troubleshoot
copy 64
print 62

R

rear access panel
illustration 6
receive faxes
answer mode 12
automatically 29
blocking numbers 33
forwarding 32
manually 29
polling 31
rings to answer 35
troubleshoot 66, 67

recycle

ink cartridges 84
redial options, setting 37
Redial/Pause 8
reduce fax 33
reduce/enlarge copies
resize to fit letter 42
resize to fit letter or A4 41

regulatory information 81
regulatory model number 84
replace print cartridges 52
reports

confirmation, fax 44
control panel button 7
error, fax 45
fax test failed 46

reprint
faxes from memory 31
resolution, fax 27
right arrow 8
rings to answer 35

S

save
 default settings 11
 faxes in memory 30

scan glass
 clean strip 59

schedule fax 25

send faxes
 basic fax 11
 color fax 26
 manually 22
 memory, from 24
 monitor dialing 24, 25
 schedule 25
 troubleshoot 66, 67, 69

serial phone systems
 countries/regions with 13

settings
 administrator 44
 control panel 11
 copy 39
 fax 27
 speed, fax 37

setup
 button 8
 distinctive ringing 36
 fax 12
 fax, with parallel phone systems 13
 test fax 46
 troubleshoot 70

setup poster 5

shipping the HP Fax 78

size
 troubleshoot copy 64

skew, troubleshoot
 copy 65
 print 63

sound pressure 75

specifications
 acoustic emissions 75
 electrical 75
 media 21
 operating environment 75
 physical 73
 processor and memory 74
 storage environment 75

speed
 copy 41

Speed Dial
 button 7

speed dial
 fax numbers, set up 19

groups, set up 19
 one-touch buttons 8
 print and view 20
 send fax 11

status
 messages 16

storage environment
 specifications 75

streaks, troubleshoot
 copies 65

subscriber identification
 code 35

supplies
 order online 73
 yields 74

support. *See* customer support

support process 78

symbols, enter 17

T

technical information
 copy specifications 74
 fax specifications 75

telephone customer support 77

telephone line, answer ring
 pattern 36

telephone wall jack, fax 47

telephone, fax from
 receive 29
 send 22

temperature specifications 75

tests, fax
 dial tone, failed 49
 failed 46
 fax line condition 50
 fax phone cord type test
 failed 49
 hardware, failed 47
 port connection, failed 48
 setup 46
 telephone wall jack 47

text
 enhance on copies 42
 enter from control panel 17
 incompletely filled on
 copies 65
 splotchy on copies 65
 troubleshoot 62
 unclear on copies,
 troubleshoot 65

tone dialing 36

transparencies
 copy 40

trays

capacities 21
 locating 6
 media sizes supported 21
 media types and weights
 supported 21
 paper guides illustration 6
 troubleshoot feeding 63

troubleshoot
 answering machines 69
 blank pages printed 61
 bleeding colors 62
 control panel messages 16
 copy 63
 copy quality 64
 fax 65
 fax dial tone test failed 49
 fax hardware test failed 47
 fax line test failed 50
 fax phone cord connection
 test failed 48
 fax phone cord type test
 failed 49
 fax tests 46
 fax wall jack test, failed 47
 jams, paper 72
 media not picked up from
 tray 63
 missing lines or dots 62
 multiple pages are
 picked 63
 paper-feed problems 63
 power 61
 print 61
 print quality 62
 receive faxes 66, 67
 send faxes 66, 67, 69
 setup 70
 skewed copies 65
 skewed pages 63
 tips 61

V

vertical stripes on copies,
 troubleshoot 65

view
 speed-dial entries 20
 voltage specifications 75

W

wall jack test, fax 47
 warning messages 16

warranty 78

Web sites

- customer support 77

- environmental programs 84

- order supplies 73

- supply yield data sheet 74

white bands or stripes,

- troubleshoot

- copies 65

white strip, clean 60

© 2008 Hewlett-Packard Development Company, L.P.

www.hp.com

Printed in Germany



CB820-90001

